



KANOMAX
The Ultimate Measurements

Handheld Particle Counter Measurement Software for Windows

3888-40

User Manual

Table of Contents

§ 1	Overview	2
§ 2	Software Setup.....	2
§ 3	Main Unit Setting	5
§ 4	Using the Software	8
	4.1 Starting the software (Main screen)	8
	4.2 Measurement procedures.....	9
§ 5	File.....	10
	5.1 New.....	10
	5.2 Open	10
	5.3 Save	11
	5.4 Exit.....	12
§ 6	Setting	13
	6.1 Selecting the communication mode.....	13
	6.2 RS-485 Setting	13
	6.3 Setting the IP address.....	15
§ 7	Measurement Parameter Setting and Start Measurement.....	17
	7.1 Setting the measurement parameters	17
	7.2 Start Measurement	19
	7.3 Stop measurement	19
§ 8	View.....	20
	8.1 Setting the parameter of the particle graph	20
	8.2 Setting parameters of the temperature-humidity data graph.....	21
§ 9	Language	22
§ 1 0	Help	22
	10.1 About.....	23
§ 1 1	Contact Information	24

§ 1 Overview

This manual describes how to operate the Handheld Particle Counter Measurement Software. This software remotely controls the Handheld Particle Counter. It monitors and displays the measured data.

1) Software specification

Items	Details
OS	Microsoft Windows 7 Microsoft Windows 10
Language	English, Chinese, Japanese, Spanish
Communication mode	Serial communication, TCP/IP(wired, wireless)

2) Operating environment

OS	Microsoft Windows 7, Microsoft Windows 10
Interface	RS-485, Ethernet, Wi-Fi
RAM	1GB or more
HDD Capacity	With free space of 500MB or more
Compatible Model	Model 3888, Model 3889

§ 2 Software Setup

1) Prior to setting up the software, exit other programs. Open the

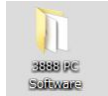

folder and double-click the setup file



to display the

dialog box as show in Figure 2-1 below:

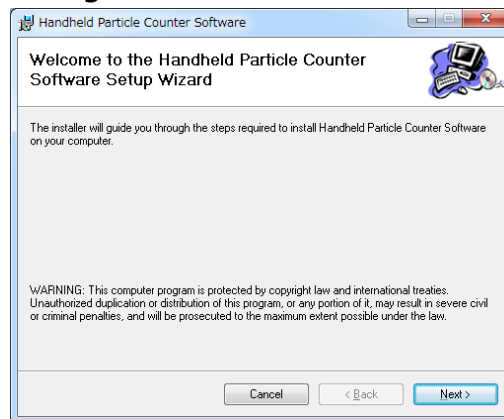

Figure 2-1

- 2) Click the Next button to display the dialog box as shown in Figure 2-2 below. To install to a different folder, enter it in the designated space or click "Browse":

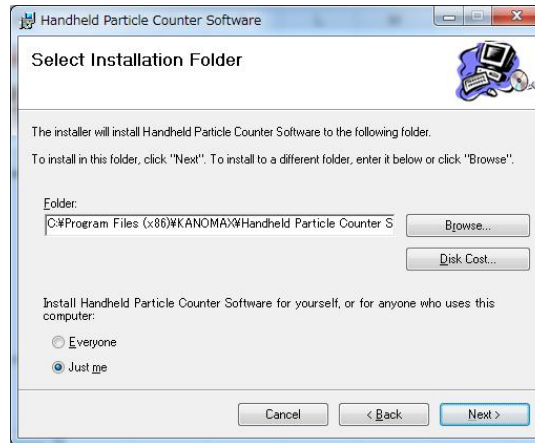

Figure 2-2

- 3) Click the Next button to display the dialog box as shown in Figure 2-3 below:

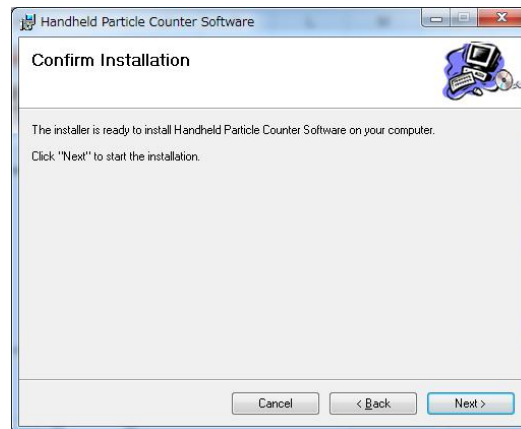

Figure 2-3

- 4) Click the Next button to display the dialog box as shown in Figure 2-4.

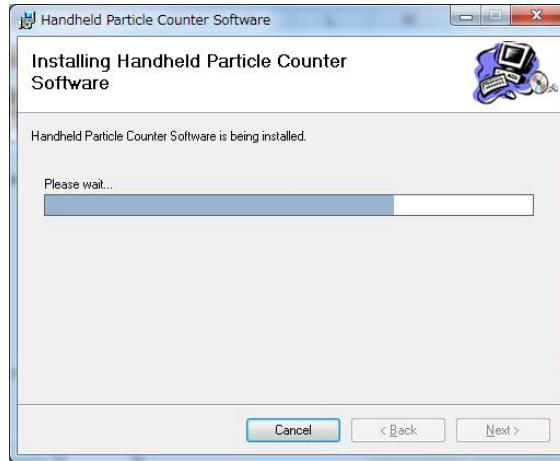

Figure 2-4

5) After a few seconds, the Installation Complete dialog box will appear as shown in Figure 2-5 below:

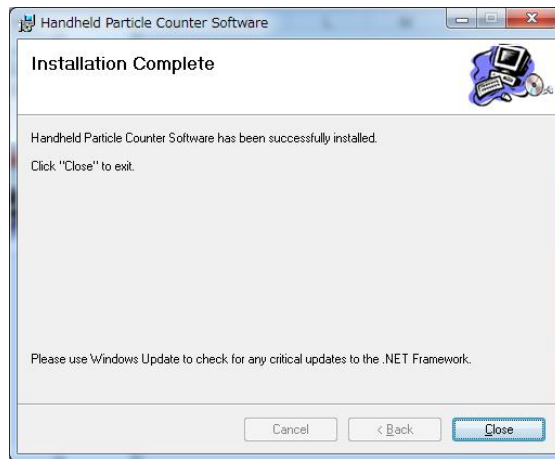

Figure 2-5











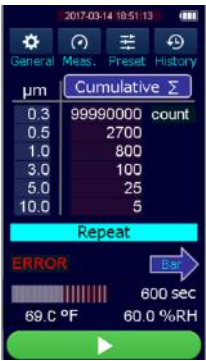

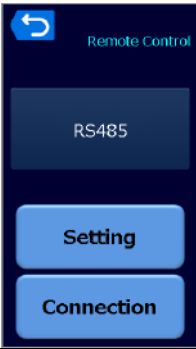
6) Click the Close button to complete the setup. The icon appears as shown in Figure 2-6 below:

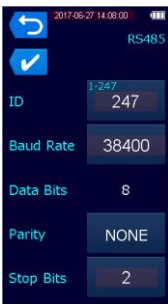
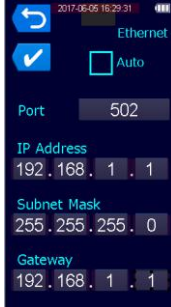

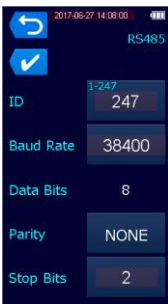
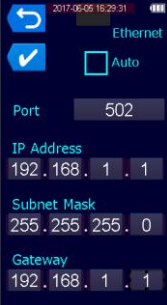
Figure 2-6

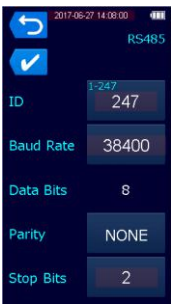
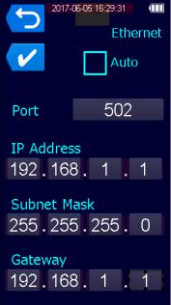
§ 3 Main Unit Setting

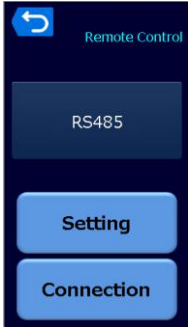
1) Setting the communication of the main unit

Step 1	Step 2	Step 3						
<p>Turn the unit on and display the main screen.</p> 	<p>Tap the Measurement Setting icon to display the Measurement Setting screen.</p> 	<p>Tap the Remote Mode button to display the next screen.</p> 						
<p>Tap the Setting button to display the Remote Setting screen.</p> 	<p>Step 5</p> <p>Select the communication method and set the communication parameter.</p> <table border="1" data-bbox="644 1081 1366 1458"> <thead> <tr> <th data-bbox="644 1081 887 1126">RS-485</th> <th data-bbox="892 1081 1129 1126">Ethernet</th> <th data-bbox="1134 1081 1366 1126">Wi-Fi</th> </tr> </thead> <tbody> <tr> <td data-bbox="644 1133 887 1442">  </td> <td data-bbox="892 1133 1129 1442">  </td> <td data-bbox="1134 1133 1366 1442">  </td> </tr> </tbody> </table>		RS-485	Ethernet	Wi-Fi			
RS-485	Ethernet	Wi-Fi						
								
<p>Step 6</p> <p>Tap the ✓ button to complete the setting. To return the previous page, tap the return button.</p> 	<p>Step 7</p> <p>Tapping the Connection button displays the Remote Measurement screen.</p> 							

2) Connecting the Hardware

RS-485: If your PC does not have RS-485 communication port, use a USB to 2-Wire RS485 converter.

HH-LPC Remote Setting > RS485	Communication parameter
Enter the ID. Select parameters.	Enter the ID. Baud rate: 9600,19200, or 38400 Parity: none, even, or odd Stop bit: 1 or 2

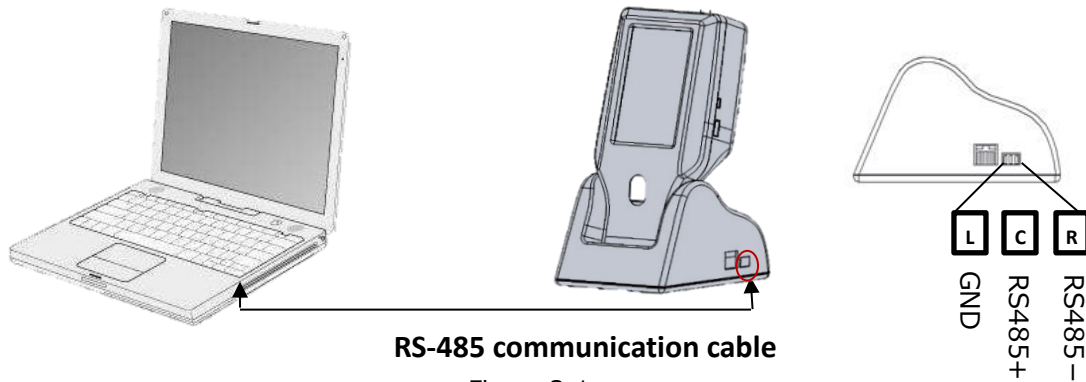

Figure 3-1

Ethernet: Use LAN cables to connect as follows:

HH-LPC Remote setting>Ethernet	Communication parameter
Auto <input checked="" type="checkbox"/> :Checked	Obtain IP address, subnet mask, and gateway automatically.
Auto <input type="checkbox"/> :No check	Enter the IP address, subnet mask, and gateway.

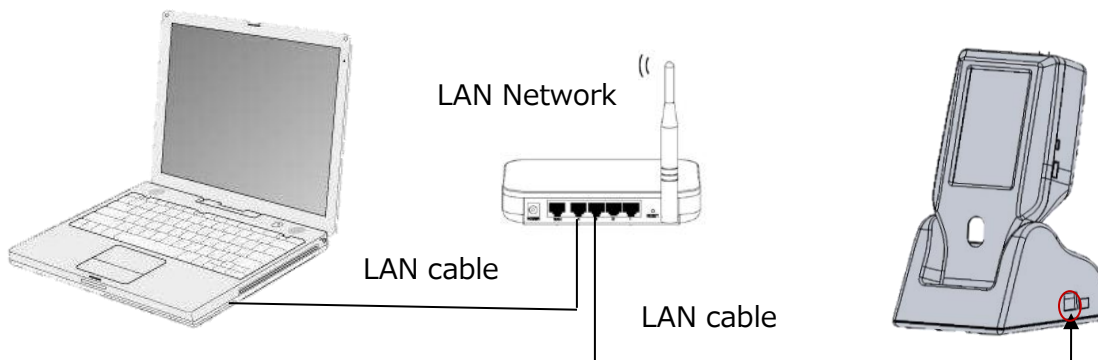

Figure 3-2

Wi-Fi:

Use the Wi-Fi function of PC to connect to 3888AP.

Network name (SSID) = HHLPC-***** (6-digit figures)

Security type = WPA2 Personal or WPA Personal

Encryption type = AES

Security key = 123456789



Figure 3-3

*If Wi-Fi remote connection is used above a metal conductor, the Wi-Fi radio wave may be reflected and affect the measured result. When using Wi-Fi connection above any metal conductor, please use a non - metallic spacer of 3 cm or more

§ 4 Using the Software

4.1 Starting the software (Main screen)

Double-click the icon  to start the software. The main screen is as shown in Figure 4-1 below:

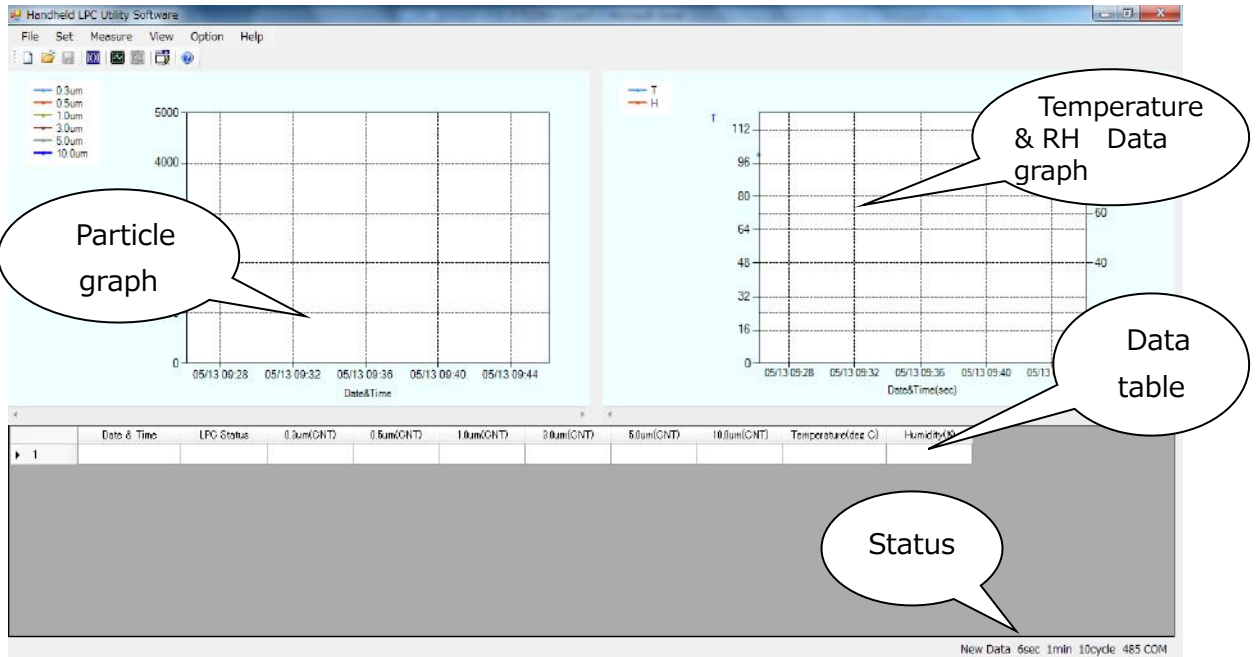

Figure 4-1



Items	Details
Particle graph	Shows the value of the particle count
Temperature & RH data graph	Shows the measured value of temperature and humidity
Data table	Shows the measurement data of particles, temperature, and humidity
Status	(See the table blow.)

Status: As shown in the following table:

Items	Details
Measurement status	Sampling, Waiting
Data status	New data, old data
Measurement parameter	Sampling time, Interval time, Repeat count
Communication mode	RS-485, Ethernet, Wi-Fi

4.2 Measurement procedures

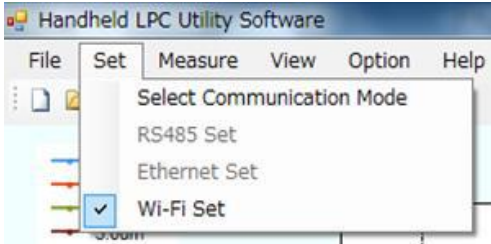
1) Configure the communication mode setting.

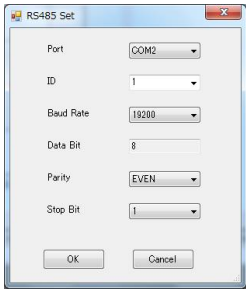
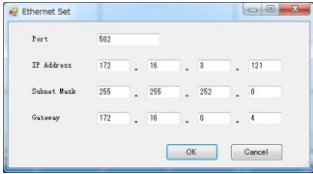
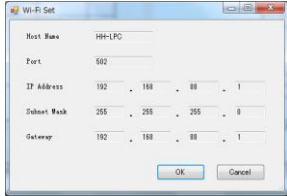
STEP1		STEP2	
Click the Set menu and then click the Communication Mode Setting. 		Select the communication mode. 	
STEP3			STEP4
RS485	Ethernet	Wi-Fi	With the counter waiting for the Remote control, Click the OK button to connect.
Set the communication parameter. 	Set the IP address of Handheld Particle Counter. 	Confirm the IP address of Handheld Particle Counter. 	

2) Start a measurement.

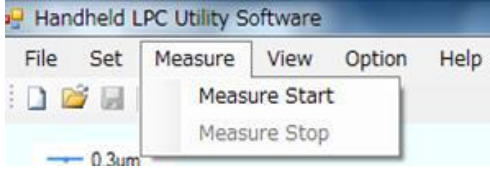
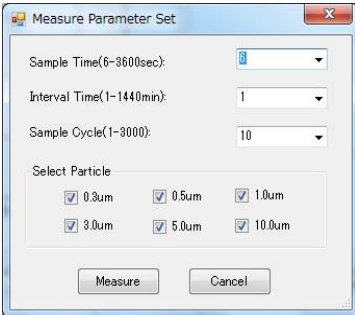
STEP1	STEP2	STEP3
Click the Measure menu and then click the Start Measurement. 	Set the measurement parameters. 	Click the Measure button to start measurement.

§ 5 File

Use this menu to create a new data file, open a data file, save a data file, and close an application.

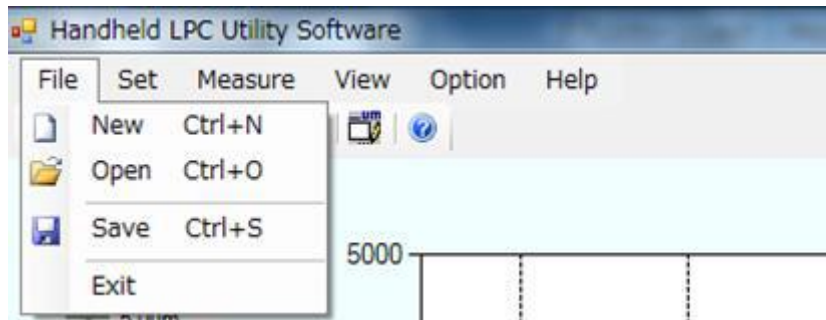



Figure 5-1 File menu

5.1 New

Open a new file window to initialize the data, particle graph, probe data graph, and status. From the File menu, Click  **New Ctrl+N** in the drop-down list (or click the  button on the toolbar; or hold down the Ctrl key and press the "N" key) to display the window.

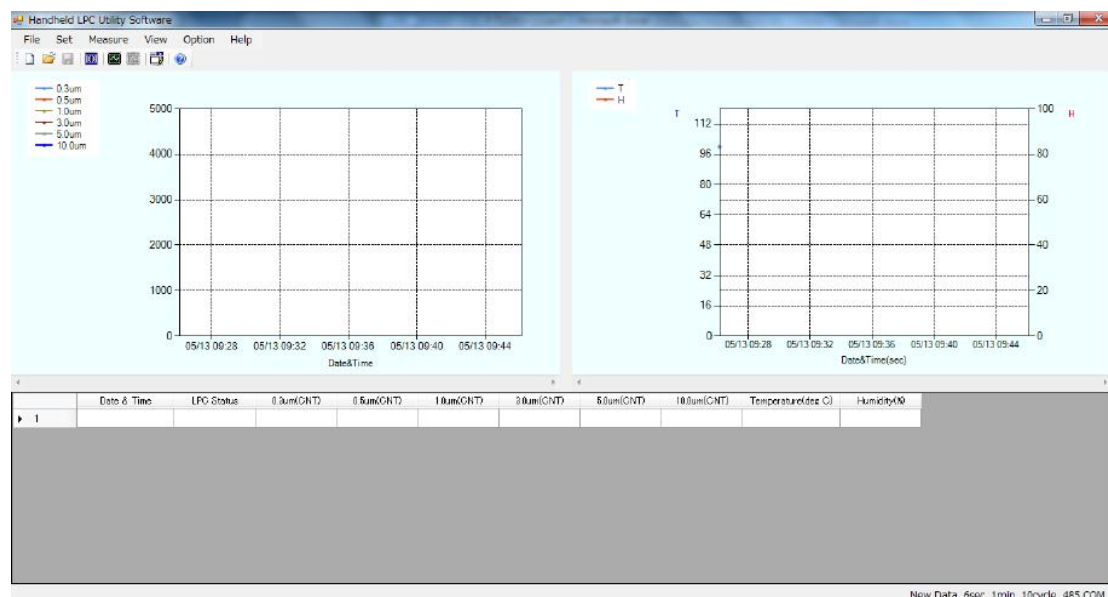



Figure 5-2 New window

5.2 Open

Open the previously measured data files (*.CSV) to display the particle graph, Temperature & RH data graph, particle data, and Temperature & RH data. From the File menu, click  **Open Ctrl+O** in

the drop-down list (or click the  button on the toolbar; or hold down the Ctrl key and press the "O" key) to display the Open dialog box.

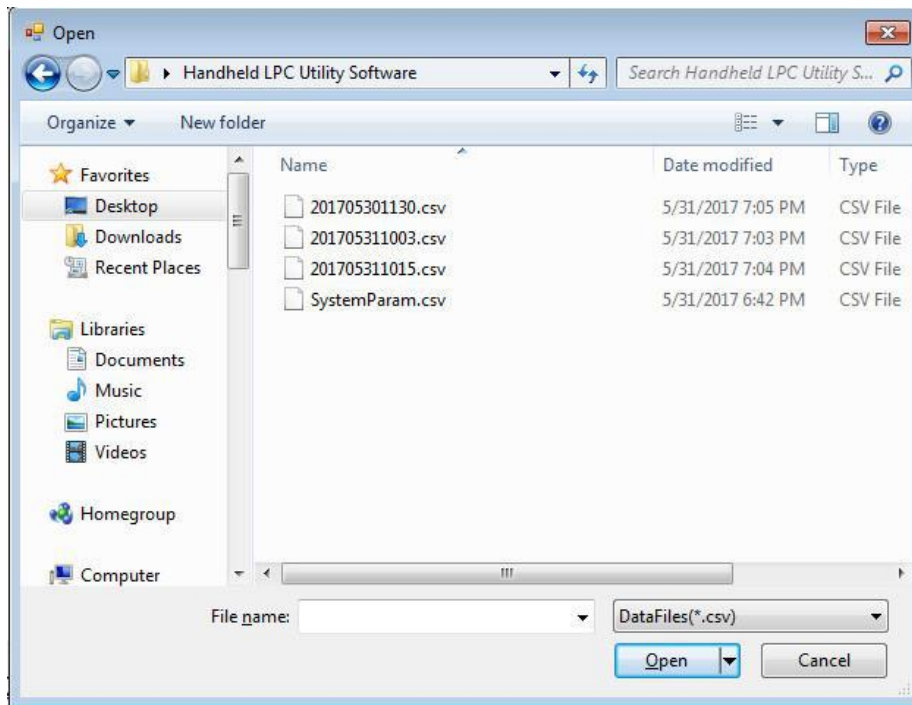

Figure 5-3 Opening data file dialog box





: Opens a data file



: Cancels opening a data file

5.3 Save

Use this menu to save the data files (*.CSV) , measurement parameter, measurement data. From the File menu, click  Save **Ctrl+S** in the drop-down list (or click the  button on the toolbar; or hold down the Ctrl key and press the "S" key) to display the Save As dialog box.

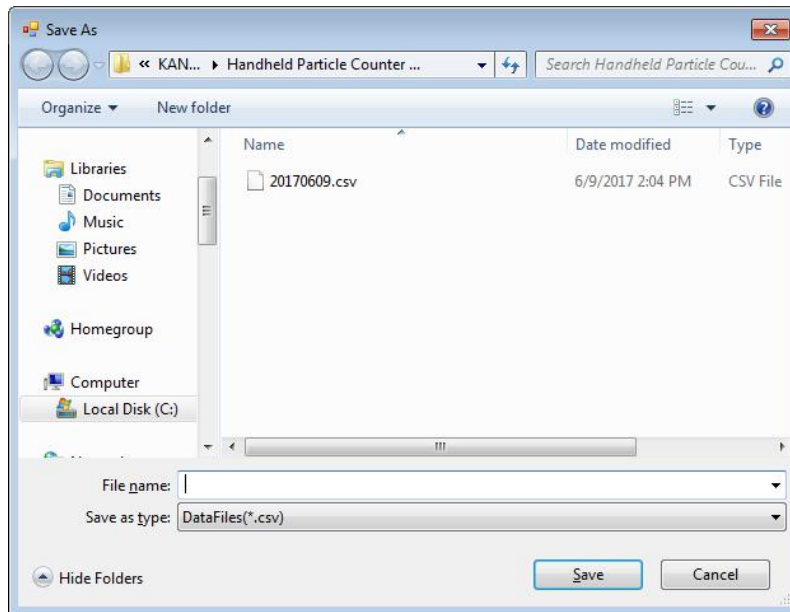
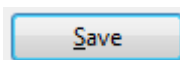
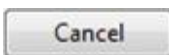

Figure 5-4: Save As dialog box



: Saves a data file



: Cancels saving a data file

5.4 Exit

From the File menu, click “Exit” in the drop-down list.

§ 6 Setting

Use this menu to set the communication mode and communication parameters. Select a measurement mode before you start measuring.

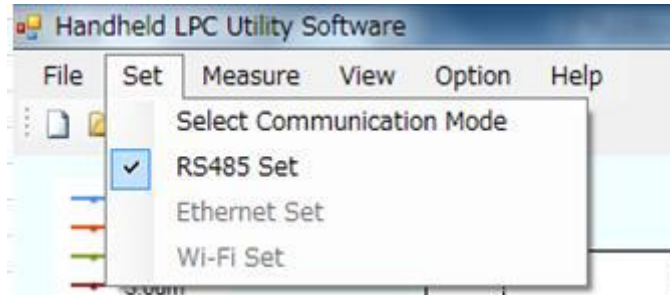

Figure 6-1 Set Menu

6.1 Selecting the communication mode



From the Set menu, click on the “Select Communication Mode” in the drop-down list (or click the  button on the toolbar) to display the dialog box as shown below.



Figure 6-2 Select Communication Mode dialog box

-  : Confirms the setting
-  : Cancels the setting

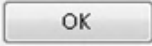
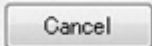
6.2 RS-485 Setting

From the Set menu, click “RS485 Set” in the drop-down list (Or click the  button on the toolbar) to display the RS485 Set dialog box.

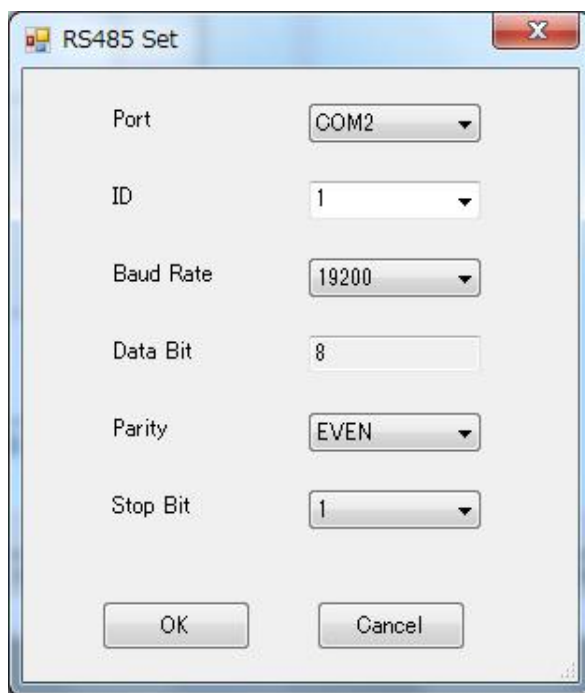

Figure 6-3 RS485 Set dialog box

Note: When setting the port, confirm the communication port to connect your PC and the Handheld Particle Counter main unit. Refer to the table below:

1) Parameter settings

Enter the communication parameter you set for the Handheld Particle Counter main unit.

Items	Details	Remarks
Port	COM1, COM2 …… COM8	Selectable
Vaud rate	9600, 19200, or 38400	Selectable
Parity	None, Even, Odd	Selectable
Data bit	8	Fixed
Stop bit	1 or 2	Selectable

2) Button functions

OK: Saves the parameters and opens the port.
 If a port error occurs, a "failure" message will be displayed. When the port is successfully connected, a "success" message will be displayed.

Cancel: Cancels the setting

6.3 Setting the IP address

Ethernet: Connect the PC and the Handheld Particle Counter using a LAN cable.

Wi-Fi: Connect the PC to 3888AP by using a wireless module of the PC.

Ethernet

From the Set menu, click "Ethernet Set" in the drop-down list to display the Ethernet Set dialog box.

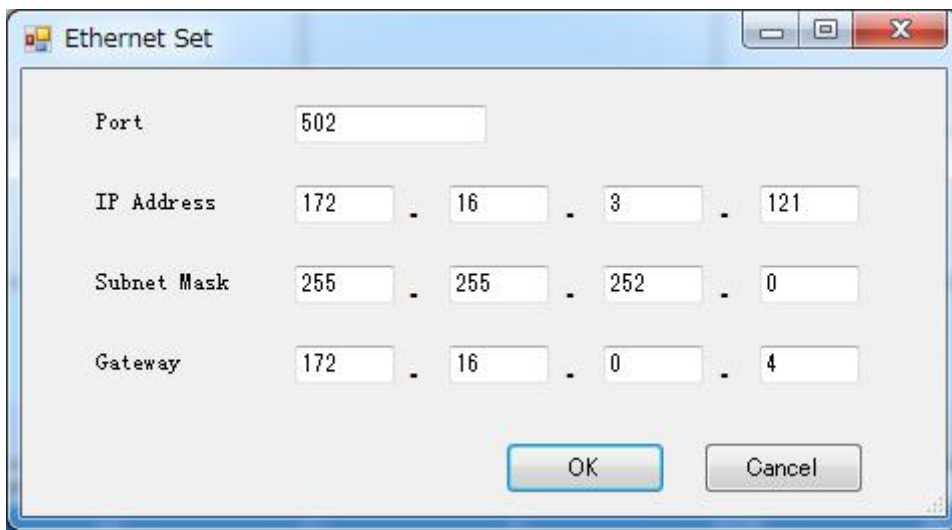

Figure 6-4 Ethernet Set dialog box

1) Parameter settings

Enter the IP address and port number set on the screen of the Handheld Particle Counter main unit.

2) Button functions

 : Saves the parameters and runs the connection.

When the connection is successfully complete, a "success" message will be displayed. Close the dialog box to start measuring. If a connection error occurs, check the connection status.

 : Cancels the setting.

Wi-Fi

From the Set menu, click on "Wi-Fi Set" in the drop-down list to display

the Wi-Fi Set dialog box.

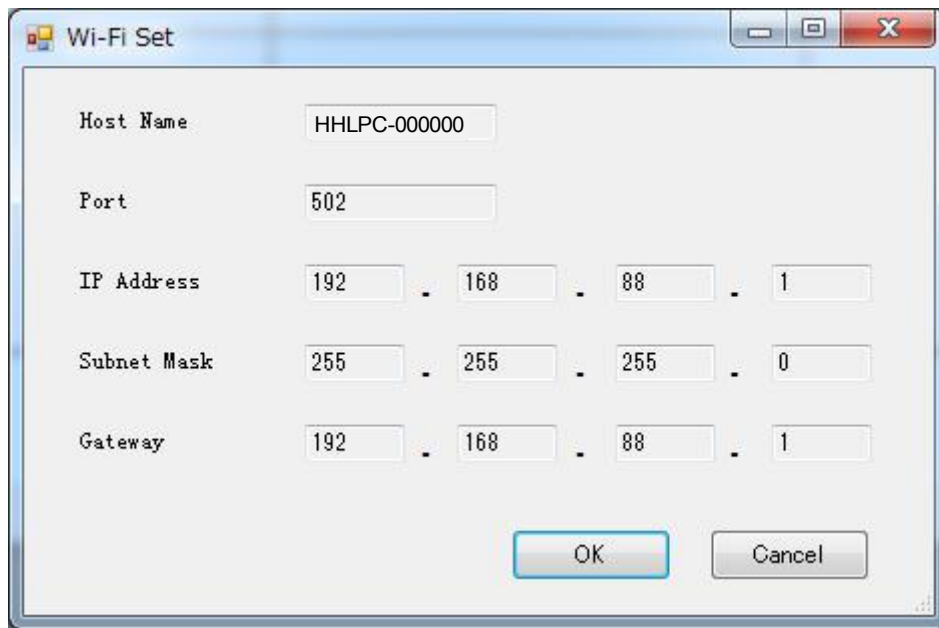
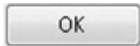

Figure 5-5 Wi-Fi Set dialog box

1) Confirm the parameter

Confirm that the communication parameters are same as the Handheld Particle Counter main unit.

2) Button functions



: Saves the parameters and runs the connection.

When the connection is successfully complete, a "success" message will be displayed. Close the dialog box to start measuring. If a connection error occurs, check the connection status.

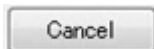

: Cancels the setting.

§ 7 Measurement Parameter Setting and Start

Measurement

Use the Measure menu to set the measurement parameters, start measurement, and stop measurement.

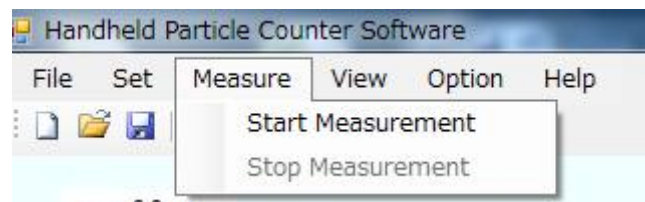



Figure 7-1 Measure menu

7.1 Setting the measurement parameters

From the Measurement menu, click "Start Measurement" in the drop-down list (or click the  button on the toolbar) to display the Measure Parameter Set dialog box as shown in Figure 7-2.

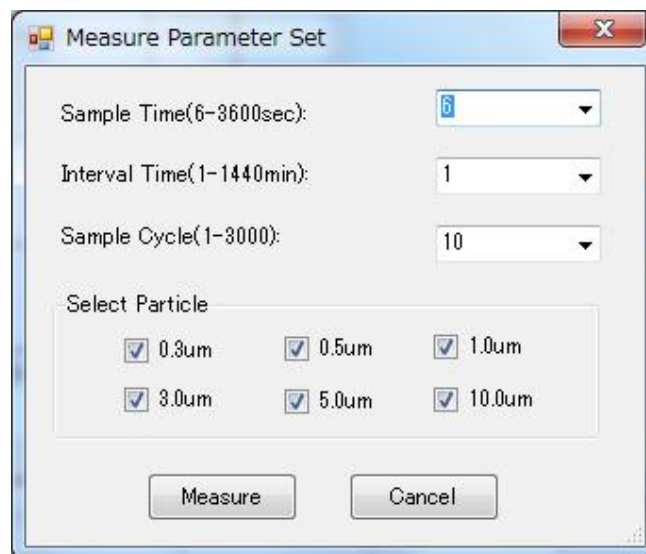

Figure 7-2 Measure Parameter Set dialog box

1) Parameter Settings

Items	Details	Remarks
Sampling time	1 to 3600 seconds	You can select or enter manually.

Interval time	1 to 1440 minutes	You can select or enter manually.
Repeat count	1 to 3000 pcs.	You can select or enter manually.
Size distribution	Model 3889 0.3 μ m,0.5 μ m,1.0 μ m 3.0 μ m,5.0 μ m,10.0 μ m	You can select 1 channel at minimum and up to 6 channels.
	Model 3888 0.3 μ m,0.5 μ m,5.0 μ m	You can select 1 channel at minimum and up to 3 channels.

2) Button functions

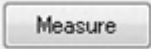
 : Saves measurement parameters and starts measuring.

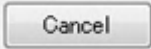
 : Cancels the saving of measurement parameters.

7.2 Start Measurement

Measurement window

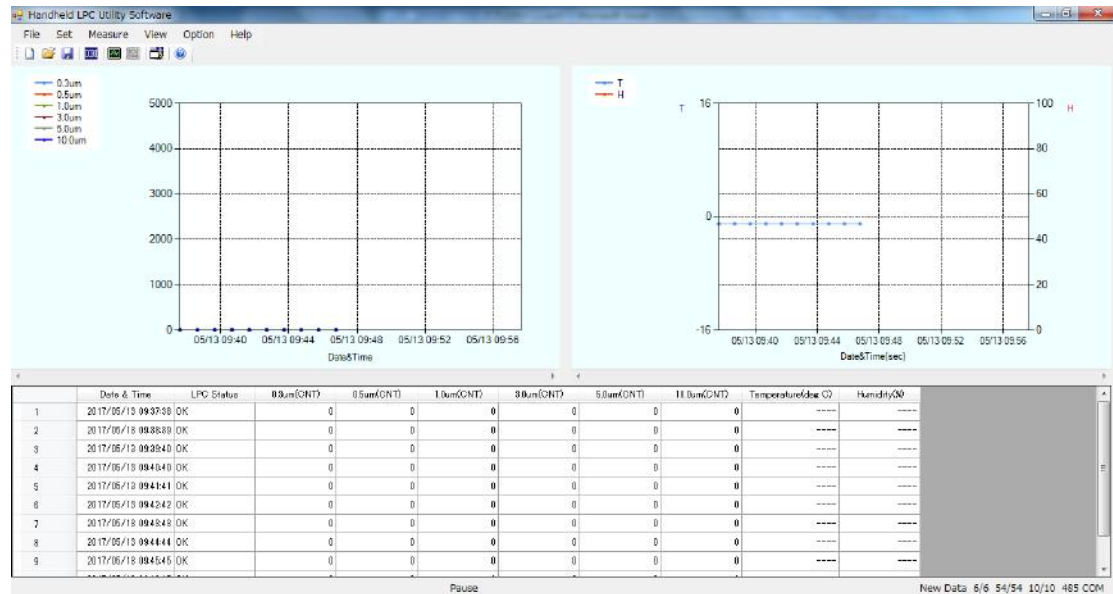



Figure 7-3 Measurement window

7.3 Stop measurement

From the Measurement menu, click “Stop Measurement” in the drop-down list (or click the  button) to display the dialog box as shown in Figure 7-4.

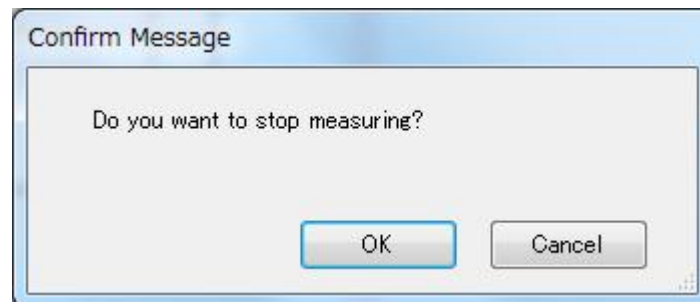

Figure 7-4 Confirm Message dialog box

 : Stops measurement.

 : Cancels the stopping of the measurement.

§8 View

Use this menu to set the particle graph and probe data graph.

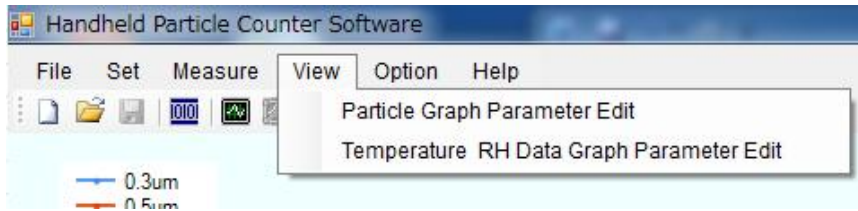



Figure 8-1 View menu

8.1 Setting the parameter of the particle graph

From the View menu, click “Particle Graph Parameter Edit” in the drop-down list (or click the  button on the toolbar) to display the Particle Graph Parameter Edit dialog box as shown in Figure 8-2 below.

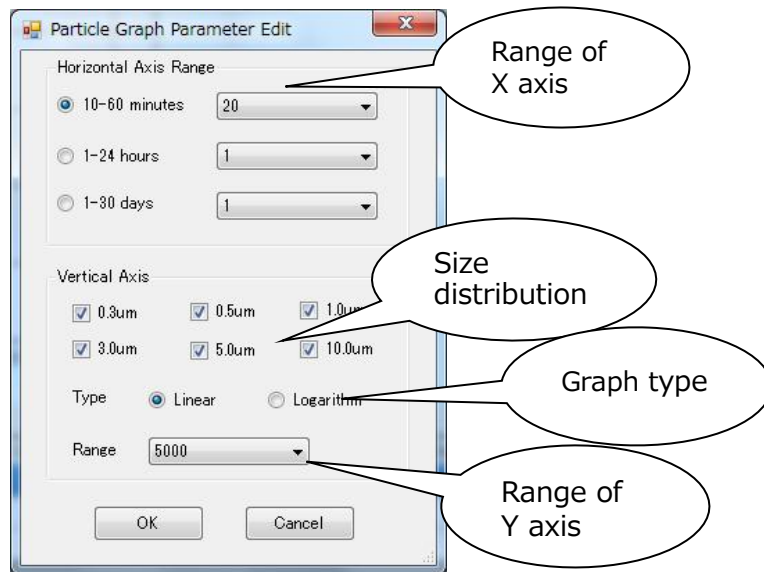

Figure 8-2 Particle Graph Parameter Edit dialog box

1) Parameter

Items	Details	Remarks
Range of X-axis	Minute (10 to 60)	10, 20, 30, 40, 50, 60
	Hour (1 to 24)	1, 2, 3…… 24
	Day (1 to 30)	1,2,3,4…… 30
Size distribution	Model 3889	0.3µm,0.5µm,1.0µm, 3.0µm,5.0µm,10.0µm

	Model 3888	0.3µm,0.5µm,5.0µm
Graph type	Linear graph, logarithmic graph	
Range of Y-axis		10,20,50,100 ……1.00E+9

2) Button functions



: Saves the graph parameters.

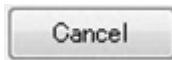

: Cancels the saving of the graph parameters.

8.2 Setting parameters of the temperature-humidity data graph

From the View menu, click “Temperature & RH Data Graph Parameter Edit” in the drop-down list to display the Temperature & RH Data Graph Parameter Edit dialog box.

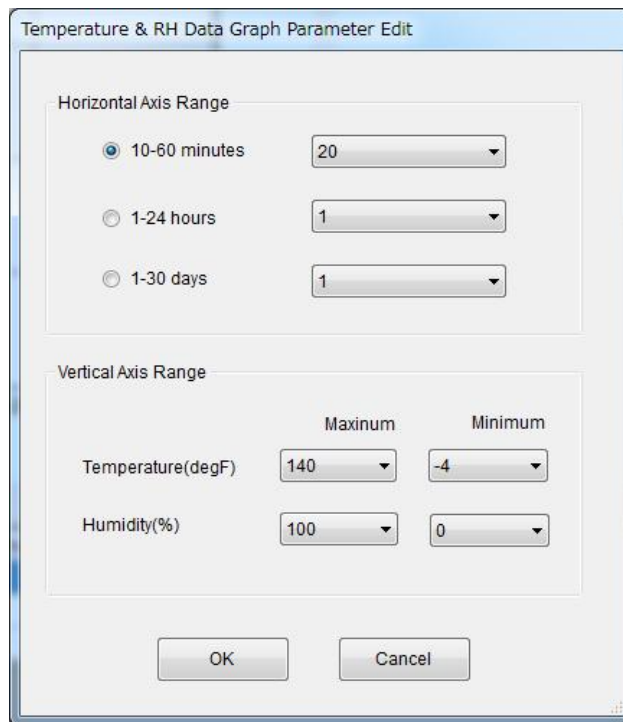

Figure 8-3 Probe Data Graph Parameter Edit dialog box

1) Parameter

Item	Details	Remarks
Range of X axis	Minute (10 to 60)	10, 20, 30, 40, 50, 60
	Hour (1 to 24)	1, 2, 3…… 24
	Day (1 to 30)	1,2,3,4…… 30

Range of temperature	Maximum : 60 Minimum : -20	
Range of humidity	Maximum: 100 Minimum: 0	

2) Button functions

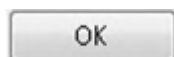

: Saves the graph parameters.

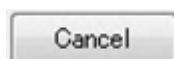

: Cancel saving the graph parameters.

§ 9 Language

Use the Option menu to select the language.

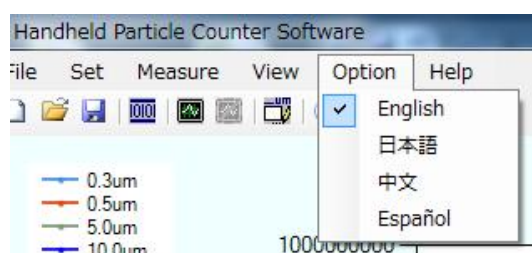

Figure 9-1 Option menu (to select the language)

- English Display in English
- 日本語 Display in Japanese
- 中文 Display in Chinese
- Español Display in Spanish

§ 1 0 Help

Use the Help menu to display the software title and version information.



Figure 10-1 Help menu

10.1 About

From the Help menu, click "About" to display the dialog box as shown below:

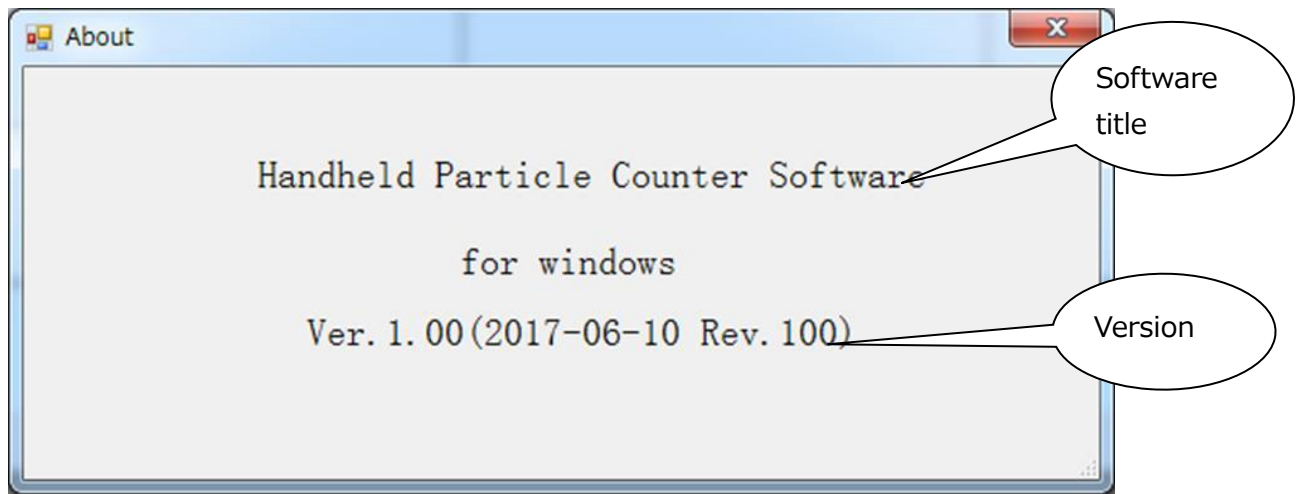

Figure 10-2 About (version information)

§ 1 1 Contact Information



- U.S.A.
KANOMAX USA, INC.
PO Box 372, 219 Route 206, Andover, NJ 07821 U.S.A.
TEL: (800)-247-8887 / (973)-786-6386
FAX: (973)-786-7586
URL: <http://www.kanomax-usa.com/>
E-Mail: info@kanomax-usa.com

- JAPAN
KANOMAX JAPAN INC.
2-1 Shimizu, Suita City, Osaka 565-0805, Japan
TEL: 81-6-6877-0183
FAX: 81-6-6879-5570
URL: <http://www.kanomax.co.jp>
E-Mail: sales@kanomax.co.jp

- CHINA
Shenyang Kano Scientific Instrument Co., Ltd.
TEL: 86-24-23846440
FAX: 86-24-23898417
URL: <http://www.kanomax.com.cn/>
E-mail: sales@kanomax.com.cn



KANOMAX
The Ultimate Measurements