



**KANOMAX**

TM

219 Route 206  
PO Box 372  
Andover, NJ 07821 USA

Phone: 1-800-247-8887  
Fax: (973) 786-7586  
info@kanomax-usa.com

---



**KANOMAX**

TM

*The Ultimate Measurements*

# **Model 6813<sup>TM</sup>** **THERMO-ANEMOMETER**

## **User Manual**



**KANOMAX**

TM

219 Route 206  
PO Box 372  
Andover, NJ 07821 USA

Phone: 1-800-247-8887  
Fax: (973) 786-7586  
info@kanomax-usa.com

---

## INTRODUCTION

Congratulations on your purchase of a 6813 Digital Thermo-Anemometer! You now own one of the most accurate, reliable, and highly regarded airflow measurement instruments available today.

Kanomax's model 6813 digital thermo-anemometer is a versatile instrument for measuring air velocity and temperature in various applications such as HVAC, aerospace development, industrial process airflow, and fluids research.

The rugged yet precise probe can be used for airstreams that have a wide range of humidity, temperature and contaminants without compromising accuracy.

Features include custom cable lengths, service temperatures up to 212°F (100°C) at the probe, high reliability, and long life.

**KANOMAX**

TM

219 Route 206  
PO Box 372  
Andover, NJ 07821 USA

Phone: 1-800-247-8887  
Fax: (973) 786-7586  
info@kanomax-usa.com

---

## Warranty

This product is fully warranted against defective materials and/or workmanship for a period of one year after purchase, provided it was not improperly used. For your protection, please use this product as soon as possible. If returned, it must be securely wrapped, sent prepaid and insured to:

Kanomax USA Inc.  
219 Route 206  
PO Box 372  
Andover, New Jersey 07821  
USA

Please include a note with name, address, telephone number and description of the problem. Although we provide assistance on Kanomax products both personally and through our literature, it is still the total responsibility of the customer to determine the suitability of the product for use in their application.

This manual is provided by Kanomax Instruments without any kind of warranty. Precautions have been taken in accurately preparing this manual; however, we neither assume responsibility for any omissions or errors that may appear nor assume liability for any damages that result from the use of the products in accordance with the information contained in the manual.



## **IMPORTANT SAFETY INFORMATION**

### **Classifications**



#### **Danger: To Prevent Serious Injury or Death**

Warnings in this classification indicate danger that may result in serious injury or death if not observed.



#### **Caution: To Prevent Damage to the Product**

Warnings in this classification indicate risks of damage to the product that may void the product warranty and/or calibration.

### **Description of Symbols**



#### **ESD Caution: To Prevent Damage to the Product**

Warnings in this classification indicate risks of damage to the product that may void the product warranty and/or calibration. Internal components are static sensitive and are not user serviceable. Opening the cases by a non-authorized service center and/or in a non-ESD safe environment may cause damage not covered by the manufacturer's warranty.



#### **Important: Mandatory Action Required**

The specific action is given near this symbol.



#### **FCC Compliance Statement**

This equipment has been tested and found to comply with the limits for a Class B digital device, pursuant to part 15 of the FCC rules. These limits are designed to provide reasonable protection against harmful interference. This equipment generates, uses and can radiate radio frequency energy and, if not installed and used in accordance with the instructions, may cause harmful interference to radio communications. However, there is no guarantee that interference will not occur in a particular situation.



**KANOMAX**

TM

219 Route 206  
PO Box 372  
Andover, NJ 07821 USA

Phone: 1-800-247-8887  
Fax: (973) 786-7586  
info@kanomax-usa.com

## **IMPORTANT SAFETY INFORMATION (continued)**



### EU – Declaration of Conformity

Kanomax declares that the product for this manual complies with the essential requirements and other relevant provisions of Directive 1999/5/EC. A copy of the Declaration of conformity is available on request.



### **RoHS** RoHS Statement

Concerning EU-Directive 2011/65/EU (RoHS 2), to the best of our knowledge, based on supplier provided information, all Kanomax brand products, are not intentionally manufactured or formulated with the following substances: Lead, mercury, cadmium, hexavalent chromium, polybrominated biphenyls (PBB), polybrominated diphenyl ethers (PBDE). Minimal levels established in the 2005 RoHS Directive still apply under Article 4(2), Annex II: 0.1% by weight in homogenous materials for lead, mercury, hexavalent chromium, polybrominated biphenyls and polybrominated diphenyl ethers; 0.01% by weight in homogenous materials for cadmium. Please be advised that we do not analyze for these substances.



### WEEE – Waste Electrical and Electronic Equipment - 2002/96/EC

Kanomax asks that all our products to be recycled at the end of their current use, to comply with local waste requirements. Kanomax supports local Waste Electrical and Electronic Equipment (WEEE) directives where they are in operation. That means that WEEE may not be disposed as unsorted municipal waste but is to be collected separately. Kanomax consumer products are therefore labeled with a crossed-out “wheeled-bin” symbol which you can see above. Further, all our products bear any other appropriate symbols for their respective region. WEEE may contain hazardous substances which may negatively affect the environment and human health when disposed of through normal channels. Kanomax is committed to reduce the negative environmental and human health effects of WEEE.



## DANGER



### **Never touch the vane assembly blades and/or thermal sensors.**

The vane assembly blades may contain sharp edges which may cause minor cuts. The assembly contains precision bearings which are sensitive and the blades are finely adjusted to specific pitches. Touching this assembly or its parts may cause damage which can affect its operation and the calibration.

NOTE: If the vane assembly head or probe head requires cleaning we recommend a fine mist of isopropyl alcohol and a fine long-haired brush or send the unit in or servicing.



### **Do not disassemble or heat the batteries, or put them into a fire.**

This may cause burns and the batteries may burst. Please dispose of used batteries in the proper manner per local ordinances.

## CAUTION



### **When measuring, ensure that the direction arrow is facing the direction of airflow.**

The arrow indicates the direction of airflow for the data provided on the calibration certificate. It is meant to allow for uniform and consistent readings as per the provided data. The probe will operate in the opposite direction but the data may be different.



### **Do not use or leave the instrument in a high temperature, high humidity, high speed airflows or dusty environments for prolonged periods.**

The instrument may not function properly out of the specified operating conditions and/or have a greatly reduced operating life span.



### **Do not subject the instrument or the probe to strong impacts.**

Dropping the instrument or the probe may cause damage or malfunction to the instrument and may change the calibration data. We recommend sending it in immediately to be checked.



## CAUTION (continued)



**Never disassemble, modify or repair the product.**

Failure to observe the above may cause damage to the instrument or the probe. It may also void the manufacturer's warranty and calibration certificate.



**Do not pick up or carry the instrument by the cable.**

It may cause a malfunction or damage to the wiring of the cable.



**Remove the batteries from the instrument when storing for long periods of time. When inserting the batteries, be sure to insert them with the polarity facing the correct direction.**

Failure to do so may cause battery leakage and subsequent damage to the instrument. The manufacturer does not recommend any specific brand of batteries but a high-quality name brand alkaline battery seems to last the longest.



**Do not wipe the instrument with a volatile solvent.**

Use neutral solvents and simple cleaners to clean the instrument with a soft cloth.



**Regularly check the head of the probe for contamination. Impurities (such as dust) on the blades and/or thermal sensor may affect the accuracy of the instrument.**

NOTE: If the vane assembly head or probe head requires cleaning we recommend a fine mist of isopropyl alcohol and a fine long-haired brush or send the unit in or servicing.



**When storing or shipping the instrument, the manufacturer recommends disconnecting the cable(s) and returning it to the original carrying case.**



## SECTION 1 - SPECIFICATIONS

### Ranges:

Probe APT275 Airflow: 50 to 7800 ft/min (feet per minute)  
0.2 to 40.00 m/sec (meters per second)

Air Probe APT100: 300 to 6890 ft/min (1.5 to 35.00 m/sec)

Temperature: (using either air velocity probe): -4° to 212°F  
(-20° to 100°C)

**Airflow Accuracy:** **APT275:**  $\pm 1.0\%$  of reading  $\pm 1$  digit  
**APT100:**  $\pm 0.50\%$  full scale  $\pm 0.75\%$  of reading  $\pm 1$  digit

**Temperature Accuracy:**  $\pm (0.3^\circ\text{C} + 0.2\%$  of reading in  $^\circ\text{C})$

Temperature accuracy examples:  $\pm 0.3^\circ\text{C}$  at  $20^\circ\text{C}$   
 $\pm 0.5^\circ\text{F}$  at  $68^\circ\text{F}$

### Resolution:

Air Velocity: 1 ft/min or 0.01 m/sec  
Temperature:  $0.1^\circ\text{F}$  or  $0.1^\circ\text{C}$

### Operating Temperature:

Instrument:  $32^\circ$  to  $125^\circ\text{F}$  ( $0^\circ$  to  $50^\circ\text{C}$ )  
Air Probes:  $-4^\circ$  to  $212^\circ\text{F}$  ( $-20^\circ$  to  $100^\circ\text{C}$ )

**Power Supply:** 3 AA alkaline batteries

**Battery Life:** Approx. 150 hours, without backlight

**Battery check:** Automatic low battery display

**Display:** 0.5" LCD, 4 digits, with LED backlight





### Options Available:

- Protective Boot and Splash-Proof Seal for the Instrument
- USB Communications
- RS232 Communications
- Analog 0-5 Volt Output
- Additional Probes, APT275 or APT100
- Extra extension and/or flexible rods
- Custom cable lengths

### Included:

- (1) 6813 Instrument
- (1) Vane-type probe head with RTD temperature sensor, choice of APT100 or APT275
- (3) Rigid extension rods with handle grip
- (1) Flexible extension rod
- (1) Probe connection cable, 5 ft.
- (3) Size AA 1.5V alkaline batteries (installed in instrument)
- (1) Hard-shell carrying case with foam liner
- (1) 6813 operation manual

## Dimensions

### INSTRUMENT

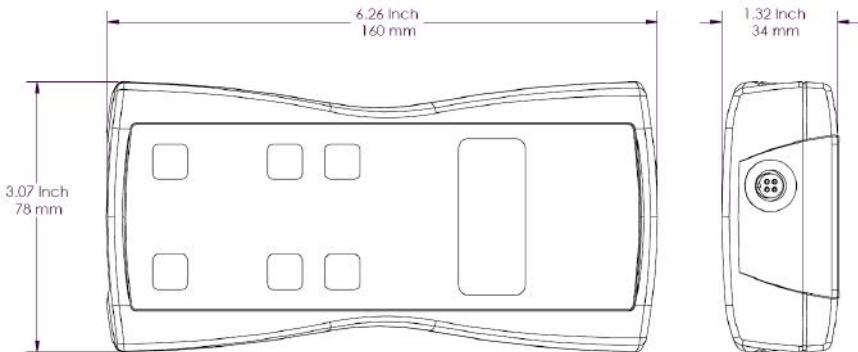



**KANOMAX**

TM

219 Route 206  
PO Box 372  
Andover, NJ 07821 USA

Phone: 1-800-247-8887  
Fax: (973) 786-7586  
info@kanomax-usa.com

### APT275 PROBE

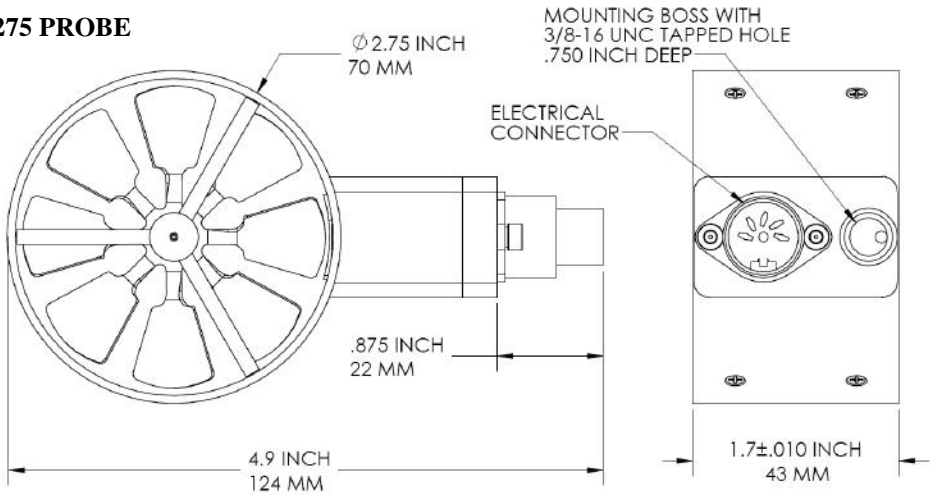

### APT100 PROBE

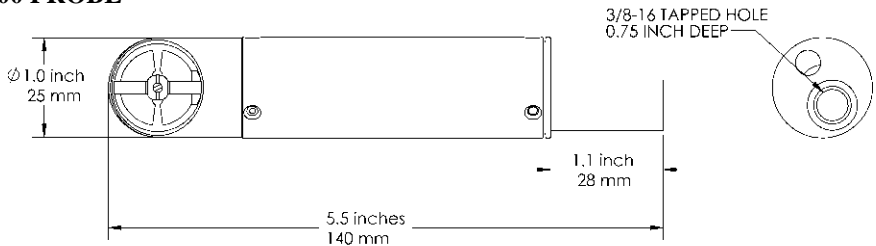



**KANOMAX**

TM

219 Route 206  
PO Box 372  
Andover, NJ 07821 USA

Phone: 1-800-247-8887  
Fax: (973) 786-7586  
info@kanomax-usa.com

## SECTION 2 – SWITCH FUNCTIONS



Pressing the ON/OFF key switches the instrument ON. Hold down the key for 2 seconds to switch the unit OFF. The unit will automatically power off after 30 minutes without any key presses. To disable auto power-off, hold down the power button during turn-on. The unit will flash AOFF, which means that the auto power-off has been disabled. The auto power-off is re-enabled each time the instrument is turned on.



Press the BACKLIGHT key to turn the LCD backlight on for 30 seconds. To turn the backlight on permanently, hold the backlight key down for 3 seconds. The LCD will flash. The backlight is now switched on permanently. To switch the backlight off, press the backlight key again.



Press the **TEMPERATURE** key to display the current temperature of the air stream as measured by the Air Probe. To switch the units between degrees Fahrenheit (°F) and degrees Celsius (°C), press the **TEMPERATURE** key again. Either **°C** or **°F** will be displayed along with the reading.



Press the **FPM/MPS** key to display the current air velocity as measured by the air probe. To switch the measurement units from FPM (feet per minute, 1 FPM resolution) to MPS (meters per second, 0.01 MPS resolution), press the **FPM/MPS** key again. Either **FPM** or **MPS** will be displayed along with the reading.



Press the **SAMPLE RATE** key to change the measurement averaging rate (“sample rate”) of the instrument **for air velocity only**.

**2SEC** An average value of airspeed measurements during the preceding 2 seconds is displayed.

**4SEC** An average value of airspeed measurements during the preceding 4 seconds is displayed.

**8SEC** An average value of airspeed measurements during the preceding 8 seconds is displayed.

**16 S** An average value of airspeed measurements during the preceding 16 seconds is displayed.

**Note:** The sample rate for **temperature** readings is **always 2 seconds**.



Press the MAX/MIN key to record and display the maximum reading for either temperature or air velocity. The maximum reading display will alternate with the letter “H” displayed with the sample rate. Press the MAX/MIN key again to record and hold the minimum reading. The minimum reading display will alternate with the letter “L” displayed with the sample rate.

For example:

*1065* alternating with *H 8* signifies that 1065 is the highest airspeed reading since the MAX/MIN key was pressed, and the sample rate is set to 8 seconds.

*82* alternating with *L 16* signifies that 82 is the lowest airspeed reading since the MAX/MIN key was pressed, and the sample rate is set to 16 seconds.

To exit MAX/MIN mode, press the SAMPLE RATE key.



Press the HOLD/RESET key to freeze the current reading on the display. **HOLD** is displayed on the LCD and the reading is held.

Press the HOLD/RESET key a second time to clear this mode and return the unit to normal operation.

Press the HOLD/RESET key while in MIN/MAX mode to display BOTH the minimum and maximum readings since the MAX/MIN key was pressed. Once the HOLD/RESET key is pressed while in MAX/MIN mode, new readings are no longer recorded. To return to MAX/MIN mode, press the HOLD/RESET key again.



**KANOMAX**

TM

219 Route 206  
PO Box 372  
Andover, NJ 07821 USA

Phone: 1-800-247-8887  
Fax: (973) 786-7586  
info@kanomax-usa.com

## APPENDIX A – LCD DISPLAY SYMBOLS

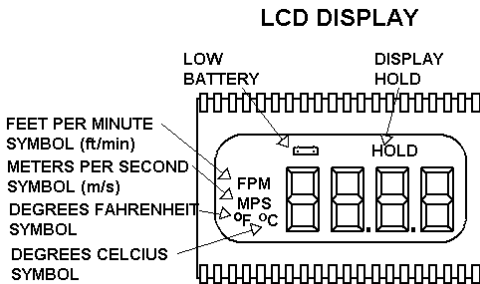

## APPENDIX B – BATTERY REPLACEMENT

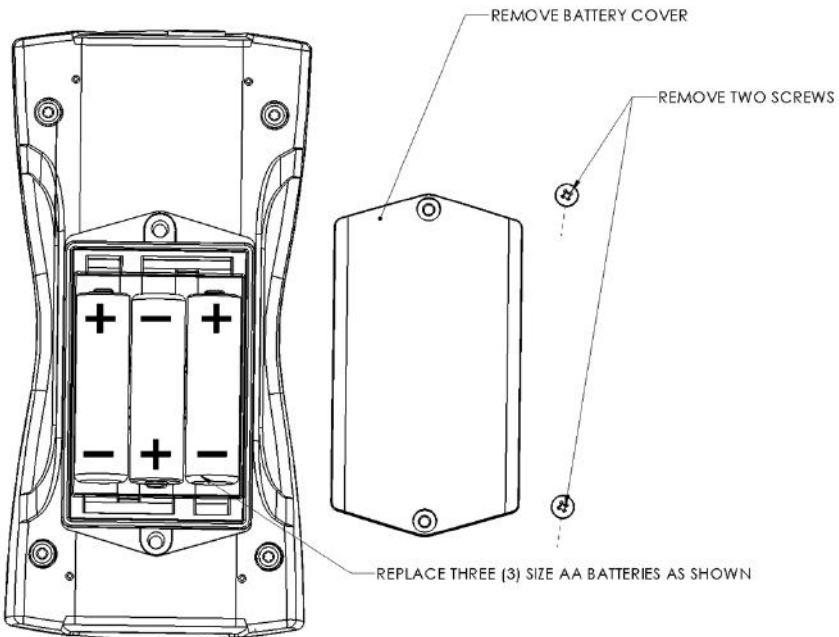



## APPENDIX C – AIRFLOW VOLUME CALCULATIONS

To calculate cubic feet per minute (CFM) from a measured air velocity (FPM), you need the calculated cross-sectional area of the air flow stream:

$$\text{Volume Flow (CFM)} = \text{Velocity (FPM)} \times \text{Area (sq ft.)}$$

In a rectangular duct this cross sectional area equals the Width times the Height.

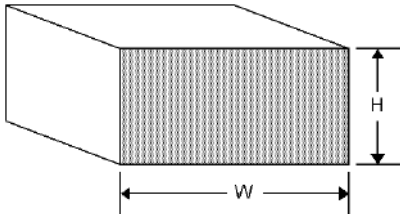

$$W \times H = A \text{ (cross-sectional area)}$$

In a circular duct this cross section area equals the radius squared times  $\pi$  (3.14).

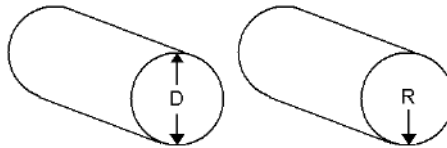

$$R \times R \times 3.14 = A \text{ (cross-sectional area)}$$

To convert an area calculated in square inches to an area calculated in square feet (which is required for the Volume Flow equation above) divide by 144: (area in sq in.)/144 = (area in sq ft.).

**Example:** The air duct is rectangular, the width is 24 in. and the height is 12 in. The air velocity reading through the duct is 450 FPM. Calculate the Volume Flow.

**Step 1:** Cross-sectional area = 24 in. x 12 in. = 288 sq in.

**Step 2:** 288 sq in /144 = 2 sq ft.

**Step 3:** Volume flow = Air Velocity x Area, therefore,  
Volume flow rate = 450 FPM x 2 sq ft. = 900 CFM.



## APPENDIX D – ANALOG OUTPUTS (IF EQUIPPED)

If the instrument is equipped with the analog output option, there will be a five-pin connector on the bottom of the instrument. Also, an analog output cable will be included with the instrument. This cable will have a five-pin connector on one end and four tinned wires on the other end.

The instrument will output a Voltage between 0 and 5 Volts that corresponds to the Air Velocity and Temperature measured by the instrument. The output range, pin assignments, and wire colors are given in the table below. Also shown is a block diagram of the analog output circuit.

Wire Color	Pin #	Function	Analog Output Voltage Range	Corresponding Measurement Range	Equation* to convert from Volts (V) to Measurement Value
BLK	1	Ground	--- N/A ---	--- N/A ---	--- N/A ---
GRN	2	Air Velocity	0 to 5 Volts	0 to 10,000 FPM	Air Velocity = 2000×V
GRY	3	--- Not Used ---	--- N/A ---	--- N/A ---	--- N/A ---
WHT	4	Temperature	0 to 5 Volts	-20°C to 80°C	Temperature [°C] = 20×V - 20

\*To convert from Volts to Air Velocity in Feet per Minute, multiply by 2000.

- ▶ For example, an analog output of 2.375 Volts on the green wire means that the instrument is measuring an air velocity of 4750 feet per minute (FPM).
- ▶  $2.375 \text{ Volts} \times 2000 = 4750 \text{ FPM}$

\*To convert from Volts to Temperature in degrees Celsius (°C), multiply by 20 and subtract 20.

- ▶ For example, an analog output of 3.458 Volts on the white wire means that the instrument is measuring a temperature of 49.16 °C.
- ▶  $3.458 \text{ Volts} \times 20 - 20 = 49.16 \text{ °C}$





**Note:** When using analog outputs, there is an **additional  $\pm 1\%$  error** in the analog output voltage. This is in addition to the normal measurement error.

- ▶ For example, an air velocity reading of 500 FPM would normally have an accuracy of  $\pm 1\%$  of reading  $\pm 1$  digit ( $\pm 6$  FPM) when the data is viewed on the LCD display.
- ▶ With the additional error associated with the analog output voltage, the effective accuracy of the analog output for this air velocity measurement will be  $\pm 2\%$  of reading  $\pm 1$  digit ( $\pm 11$  FPM).

Custom Analog Voltage Outputs are also available – contact Kanomax for details.

### Analog Output circuit block diagram and connector pin assignment

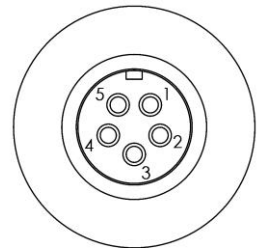
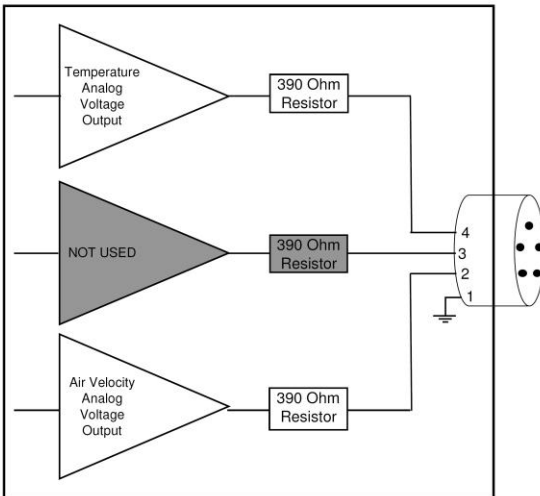

ANALOG OUTPUT CONNECTOR  
PINOUT DIAGRAM

Mating Cable Connector:  
Binder Part No. 99-0413-00-05



## **APPENDIX E - USB DATA OUTPUT (IF EQUIPPED)**

If the instrument is equipped with the USB Communications option, there will be a four pin male connector on the bottom of the instrument. Also, a USB cable will be included with the instrument. This cable will have a four pin female connector on one end and a USB Type-A connector on the other end.

### **USB Data Output – Instructions for Use**

**STEP 1:** Install a Virtual COM Port (VCP) Driver on your computer. Free VCP drivers can be downloaded for Windows, Linux, and MAC from FTDI Ltd on their website:  
<http://www.ftdichip.com/Drivers/VCP.htm>

We recommend downloading the setup executable, which automatically runs and configures the drivers for you.

**STEP 2:** Connect the USB cable (included) to the male connector on the bottom of your instrument. Connect the other end to a USB port on your computer.

**STEP 3:** Turn the Instrument ON.

**STEP 4:** Verify that the Instrument has been set up as a USB Serial Port with a unique COM port number. (You only need to do this once)

For Windows users, open the Windows Device Manager (found in Control Panel) and verify that a USB serial port exists as shown below.

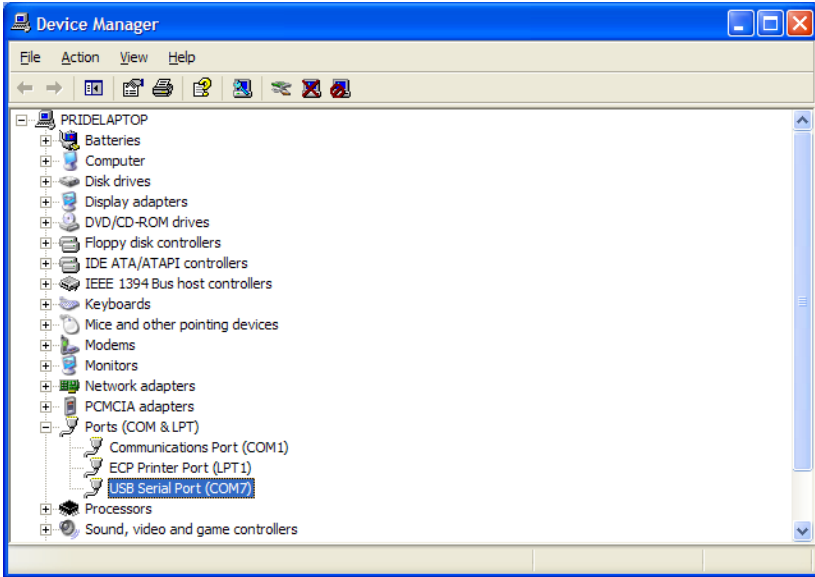

You are now ready to capture the data being measured by your instrument.

Please refer to **Appendix G – Viewing and Capturing Data** for further instructions.

**NOTE: Units with USB or RS232 communications, output only Air data at this time. Temperature data is not available on the output.**



## **APPENDIX F – RS232 COMMUNICATIONS (IF EQUIPPED)**

If the instrument is equipped with the RS232 Communications option, there will be a three pin male connector on the bottom of the instrument. Also, an RS232 cable will be included with the instrument. This cable will have a three pin female connector on one end and a DB9 Female connector on the other end.

### **RS232 Data Output – Instructions for Use**

**STEP 1:** Connect the RS232 cable (included) to the female connector on the bottom of your instrument. Connect the other end to an RS232 port on your computer.

**STEP 3:** Turn the Instrument ON.

**STEP 4:** Verify that the Instrument has been set up as a RS232 Serial Port with a unique COM port number. (You only need to do this once). For Windows users, open the Windows Device Manager (found in Control Panel) and verify that a serial port exists.

You are now ready to capture the data being measured by your instrument.

Please refer to **Appendix G – Viewing and Capturing Data** for further instructions.



## APPENDIX G – VIEWING AND CAPTURING DATA (IF EQUIPPED WITH EITHER USB OR RS232 OUTPUTS)

*NOTE: HyperTerminal is no longer included with Windows Vista or later packages. Previous manuals referenced this program. We now reference, Parallax Serial Terminal.*

*There are many terminal emulator programs available on the market. It is up to the end-user to determine which program is compatible with his/her system, what settings it may require and the Kanomax product being used. Kanomax does not endorse or recommend any of these programs and assumes no liability for their use.*

There are many ways to capture the serial port data from the Kanomax instrument. The simplest method is to use a terminal emulator program.

Using a terminal emulator allows the serial COM port to be opened, with the below port settings, and real-time data to be viewed from the instrument. One such terminal emulator program is Parallax Serial Terminal, available from [www.parallax.com](http://www.parallax.com).

Open the Parallax Serial Terminal, based on how you installed the program onto your computer. The below screen will come up.

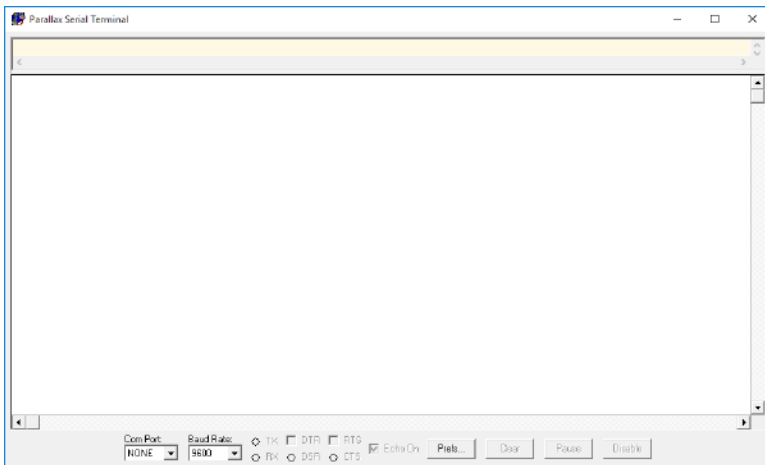

Attach your instrument & probe to your computer via the USB cable. Select the appropriate 'Com Port:'. In the below example, COM5 is being used.



219 Route 206  
PO Box 372  
Andover, NJ 07821 USA

Phone: 1-800-247-8887  
Fax: (973) 786-7586  
info@kanomax-usa.com

Set the 'Baud Rate:' to 9600

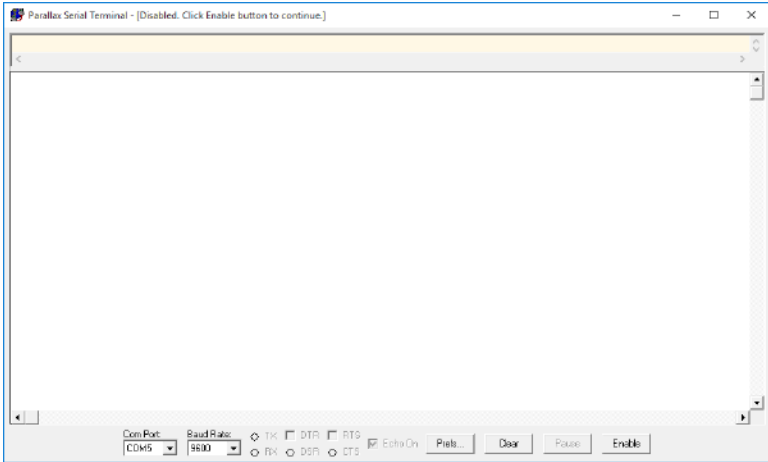

You will now receive data from your instrument. The graphic below shows the serial port output data from Parallax Serial Terminal when connected to a Kanomax 6813 Instrument. CFM was selected part way through. Graphics may vary.

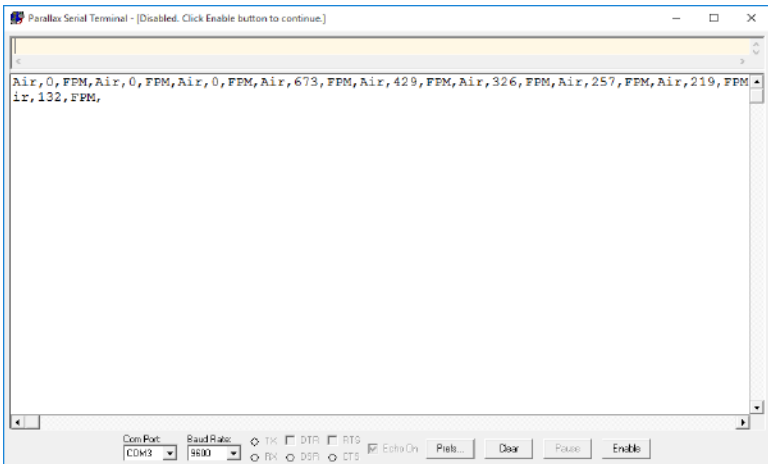



**KANOMAX**

TM

219 Route 206  
PO Box 372  
Andover, NJ 07821 USA

Phone: 1-800-247-8887  
Fax: (973) 786-7586  
info@kanomax-usa.com

### Serial Port Settings

Bits per Second (Baud)      9600

### Serial Port Protocol

Data Output Interval      One Second  
Data Format                  Comma-Separated Values (CSV)  
Measurement Units        Same as Units shown on LCD Display

Below are examples of the formatted output data for Kanomax 681x Instruments (units may be different depending on the units selected on the LCD display):

Model 6812 displaying in Air Velocity Mode:      Air,47,FPM  
Model 6812 displaying in Volume Flow Mode:      Air,251,CFM  
  
Model 6813:    Air,47,FPM  
  
Model 6815:    Air,47,FPM

**NOTE: Units with USB or RS232 communications, output only Air data at this time. Temperature data is not available on the output.**



## Exporting and Graphing Data

Exporting serial port instrument data from the Kanomax instrument to a spreadsheet application such as Microsoft Excel or OpenOffice Calc allows the data to graphed or recorded.

The simplest way to export the instrument data is to use a terminal emulator program, like Parallax Serial Terminal, and either capture the serial data/text to a file (menu selection) or to manually highlight, copy, and then paste the instrument data into an editor such as Windows Notepad.

Once you have the instrument data in a file, save the file as a .CSV type (e.g., InstrumentData.csv).

Open the file in a spreadsheet application such as Microsoft Excel or OpenOffice Calc. A graph of the data as shown below can now be generated.

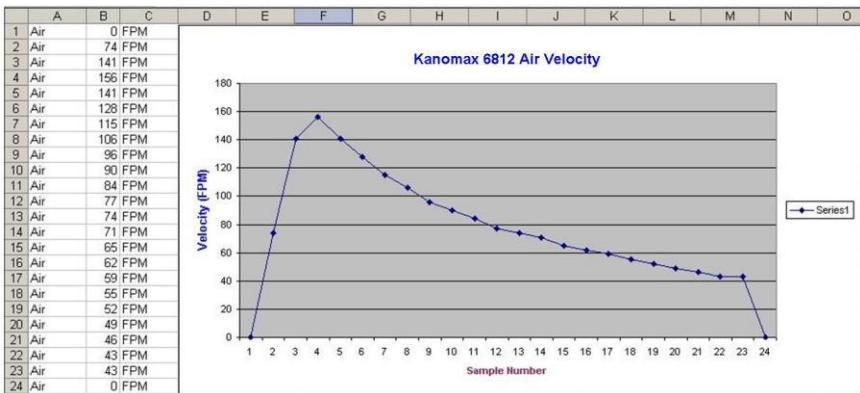





**KANOMAX**<sup>TM</sup>

219 Route 206  
PO Box 372  
Andover, NJ 07821 USA

Phone: 1-800-247-8887  
Fax: (973) 786-7586  
info@kanomax-usa.com

---

## Notes:



**KANOMAX**<sup>TM</sup>

219 Route 206  
PO Box 372  
Andover, NJ 07821 USA

Phone: 1-800-247-8887  
Fax: (973) 786-7586  
info@kanomax-usa.com

---

## Notes:



**KANOMAX**

TM

219 Route 206  
PO Box 372  
Andover, NJ 07821 USA

Phone: 1-800-247-8887  
Fax: (973) 786-7586  
info@kanomax-usa.com

---

## **CALIBRATION**

To maintain your instrument in top working order, we recommend that you send it back to us for calibration each year, beginning one year after purchase.

Our calibration services include ensuring the instrument performs within its accuracy tolerance, making any necessary adjustments, and inspecting all aspects of the instrument's functionality so that you'll have another year of dependable service. Calibration also includes a complimentary firmware upgrade so that you know you'll have the latest advances in accuracy and reliability in your instrument.

NIST-Traceable multi-point calibration is also available from the factory. We can offer precise calibration tailored to your specific measurement needs using our state-of-the-art facilities and calibration equipment.

Please contact us or visit our website for the latest information on calibrating your instrument.



**KANOMAX**

TM

219 Route 206  
PO Box 372  
Andover, NJ 07821 USA

Phone: 1-800-247-8887  
Fax: (973) 786-7586  
info@kanomax-usa.com

---



**KANOMAX**

*The Ultimate Measurements*

**Kanomax USA, Inc.**

219 Route 206

PO Box 372

Andover, New Jersey 07821

USA

(800) 247-8887

Fax: (973) 786-7586

info@kanomax-usa.com

**[www.kanomax-usa.com](http://www.kanomax-usa.com)**

**Copyright © 2016, Kanomax USA, Inc**