



KANOMAX
The Ultimate Measurements

TABmaster Mini

Model 6750

User's Manual

Overview

TABmaster Mini (Model 6750) is a portable airflow meter for measuring airflow at the intake and exhaust points of a HVAC system.

The size of the provided hood is 355×355 mm (approximately 14" x 14"). The edge of the hood, that touches walls or other surfaces, is hemmed with a dust- and stain-repellent urethane material. This aids in the creation of an airtight seal and prevents air leaks due to an uneven surface.

Transparent material is used for the hood, so you can easily align it to ventilation openings.

The support poles are made of strong, lightweight fiber rods.

This instrument uses a 16-point detection method to achieve high accuracy and maintain measurement repeatability. Airflow is detected by the 16 individual pressure sensors, and then the average result is displayed.

You can also set the atmospheric pressure manually to minimize differences due to changes in atmospheric pressure at the time of measurement.

List of Components

■ Standard

Item name	Composition	Model	Quantity
TABmaster Mini	Main Body, Indicator, Indicator fixing jig, Extension rod, Carrying case, Hood, USB cable, Main Body to Indicator cable, Batteries, Measuring software, User's Manual, Test Sheet & Calibration Certificate	6750	1

■ Optional Extras

Item name	Specification	Model
Spare hood	For replacement	6750-01
Spare hood fabric	For replacement	6750-04
Spare Support poles	For replacement (4 poles)	6750-07
USB communication cable	Spare cable	6750-09
Printer		DPU-S245
Printer roll paper	1 roll for Portable Printer	TP-5RLPK
Printer cable		6750-10
AC adaptor		3887-01
International Plug Adapter		301ADAPT

Important Safety Information

The symbols for the warnings in this manual are defined as below:

Classifications



Danger: To Prevent Serious Injury or Death

Warnings in this classification indicate a danger that may result in serious injury or death if not observed.



Caution: To Prevent Damage to the Product

Warnings in this classification indicate risk of damage to the Product that may void the product warranty if not observed.

Description of Symbols



△This symbol indicates a condition that requires caution (including danger). The subject of each caution is illustrated inside the triangle (e.g. the high temperature caution symbol is shown on the left).



⊘This symbol indicates a prohibition. Do not take the prohibited action shown inside of or near this symbol (e.g. the disassembly prohibition symbol is shown on the left).



●This symbol indicates a mandatory action. A specific action is given near the symbol.



Danger



Forbidden

Never bring the instrument to a flammable gas atmosphere. The heated instrument may cause a fire or explosion.



Handle properly

Use the instrument properly by carefully following the directions in this manual.

Misuse of the instrument may result in an electric shock, fire or instrument malfunction.



If abnormal noises, smells and/or smoke occur, or if liquid enters the instrument, turn off the instrument immediately and remove the batteries or unplug the power supply.

There is a possibility of electric shock, and/or fire or malfunction of the instrument. Contact your distributor for repair service.



Caution



Handle properly



Always unplug the instrument from the electrical outlet when it is not in use.

Failure to do this may cause an electric shock, fire or circuit damage.



Forbidden

Do not expose the instrument to rain or water drops.

Otherwise, it may cause an electric shock, fire or circuit damage.



Forbidden

Never drop the unit or place heavy objects on it.

Otherwise, it may cause damage or malfunction to the instrument.



Disassembly prohibition

Never disassemble, modify or repair the product.

Failure to observe the above may cause a short circuit and/or other failures that will affect the performance.



Handle properly

Use only the provided AC adaptor.

Using a commercially available AC adaptor will cause a malfunction.



Forbidden

Do not use or leave the instrument in a high temperature, high humidity or dusty environment. Do not leave this instrument under direct sunlight for a prolonged period.

The instrument may not function properly out of the specified operating conditions.



Handle properly

Remove the batteries from the battery compartment when storing the instrument for a long period. Do not leave exhausted batteries in the battery compartment. When inserting batteries, be sure to insert batteries with the polarity facing the correct direction.

Failure to do this may cause battery leakage or malfunction.



Forbidden

Do not wipe the instrument with a volatile solvent.

The instrument body may deform or deteriorate. Use a soft dry cloth to remove stains. If stains persist, soak the soft cloth in a neutral detergent and wipe the instrument with the soft cloth. Never use volatile solvents such as thinner or benzene.



Forbidden



Charging caution

Discharge any built-up static electricity from your body before touching the instrument.

The built-up static electricity may influence the reading and cause damage to the circuit.



Forbidden

Do not move this instrument from a cold place to a warm place quickly. It will cause condensation.

Even when used in an environment within the specified operating temperature and humidity, a sudden temperature change may cause condensation. Condensation generated on the sensor may cause inaccurate measurements. Condensation on metal part may cause rusting and lead to a malfunction.



Forbidden

Do not touch the LCD screen with a sharp-pointed object or with excessive pressure.

It may cause distortion of the screen or a malfunction. A rapid temperature change may cause a malfunction of the screen.



Handle properly

When storing the instrument, put the instrument in the carrying case and keep it in a place with an ambient temperature of -10 to 50°C and no condensation.



Forbidden

Do not dispose of the instrument as household waste.

Please note that the disposal of the instrument and the batteries should be in line with your local or national legislation. For details, please contact your local distributor.

Table of Contents

Overview	2
List of Components.....	2
Important Safety Information	3
Chapter 1 Part Names and Functions	7
Main Body.....	7
Indicator	8
Hood	8
Extension Rod	8
Chapter 2 Installing and Assembling the Hood.....	9
Installing the Hood.....	9
Assembling the Hood and Frame	9
Adjusting the Extension Rod.....	9
Assembling the Indicator and Jig	10
Connecting the Main Body and Indicator	10
Chapter 3 Operation Procedure.....	11
AC-powered Operation	11
Battery-powered Operation.....	11
Turning the Power ON/OFF	12
Operating the Instrument	13
Chapter 4 Taking a Measurement.....	14
Main Screen.....	14
Taking a Measurement and Storing the Data	14
Chapter 5 Menu Operation	16
Displaying the Menu Screen	16
IDset (ID Setting)	16
Display (Read)	17
Delete (Delete)	18
UPLink (Send)	19
Print Settings	Error! Bookmark not defined.
Chapter 6 Other Settings	23
Settings Screen	23
Setting and Storing the Airflow Unit.....	23
Setting and Storing the Temperature Unit.....	24
Setting and Storing the Atmospheric Pressure Unit.....	24
Setting and Storing the K-Factor	24
Chapter 7 Main Specifications	26
Chapter 8 Troubleshooting.....	27
Chapter 9 Warranty and After-sales Services	28
Contact Information	29

Chapter 1 Part Names and Functions

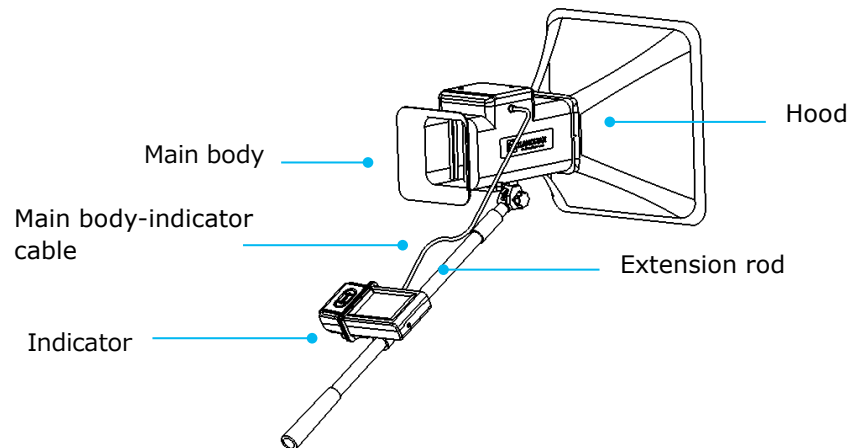

Main Body

■ External structure

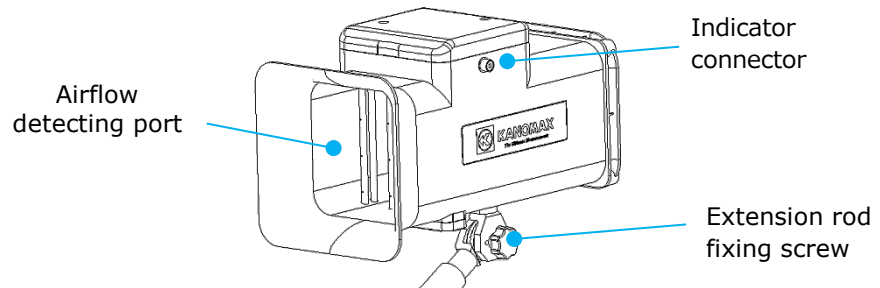

■ Internal structure

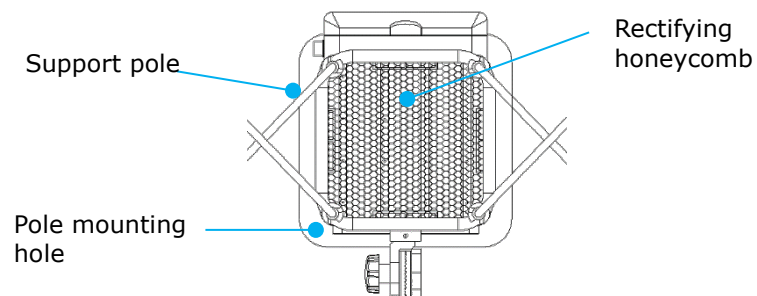

■ Sampling Tube Matrix

Measures airflow at 16 measuring points.

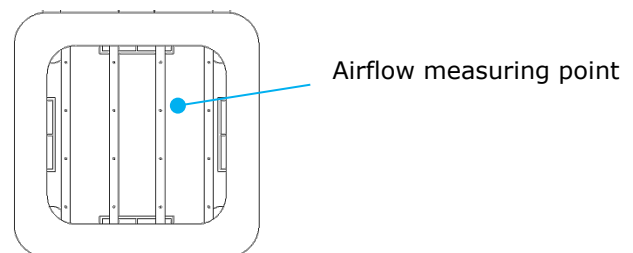

Indicator

■ Front

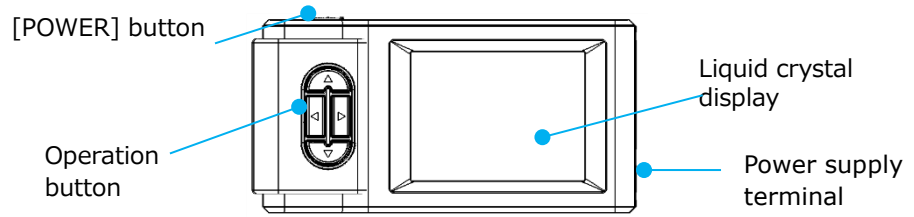

■ Back

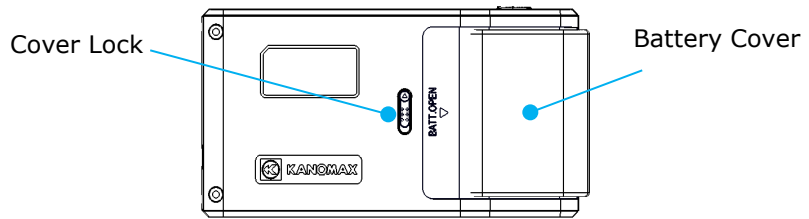

■ Top

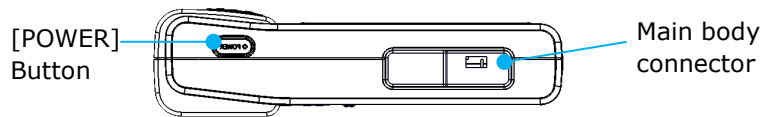

Hood

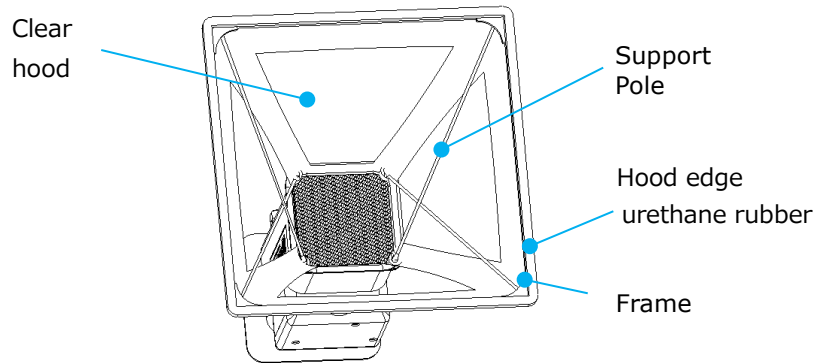

Extension Rod

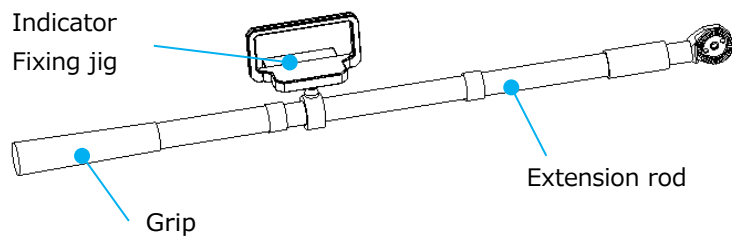

Chapter 2 Installing and Assembling the Hood

Installing the Hood

Match the stitching lines of the fabric hood to the corners of the main body to install the hood.

If the hood is twisted, it cannot be installed properly.

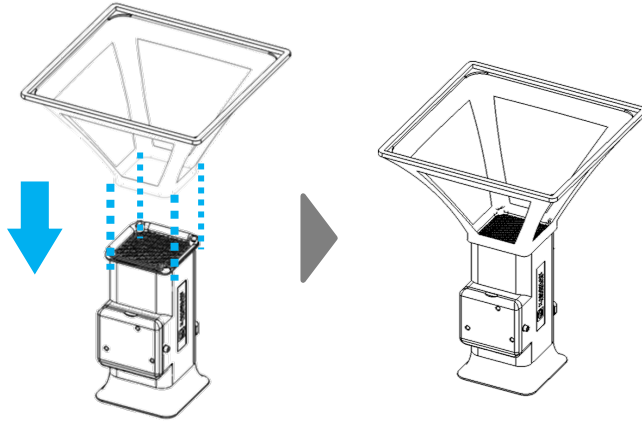

Assembling the Hood and Frame

- Insert the tip of the support pole into the pole mounting hole (see Fig. ①).
- Insert the other end of the support pole into the corner of the frame (See Fig. ②).
- Refer to Fig. ③ for the position of the other 3 poles and repeat the above steps.
The support poles must be assembled crosswise.
- To remove a support pole, reverse the assembly steps.

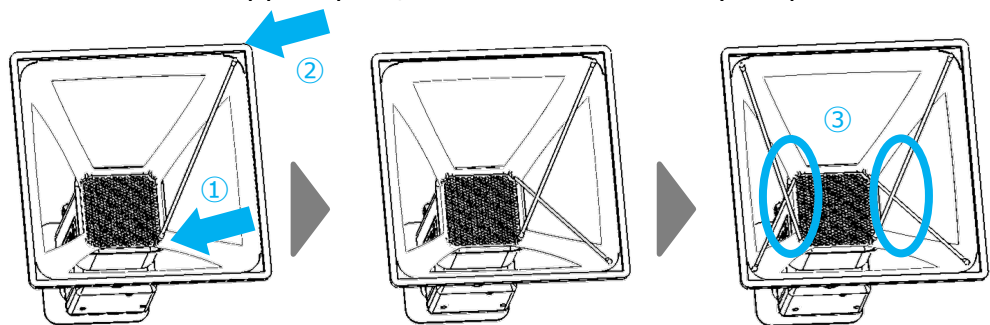

Adjusting the Extension Rod

- Release the screw lock of the extension rod. Extend the length of the rod as required and tighten the screw to fix it in place.

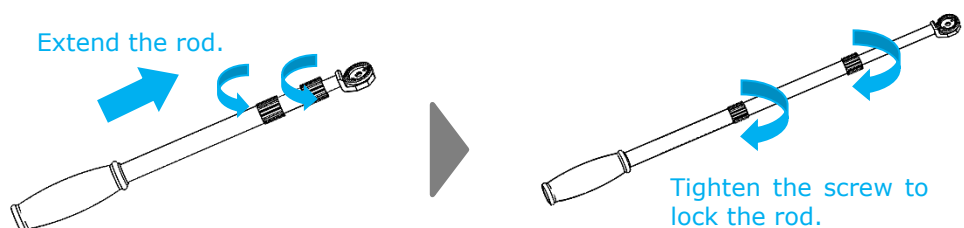

- Connect the tip of the extension rod to the extension rod connecting base. Adjust the angle as required and lock it.

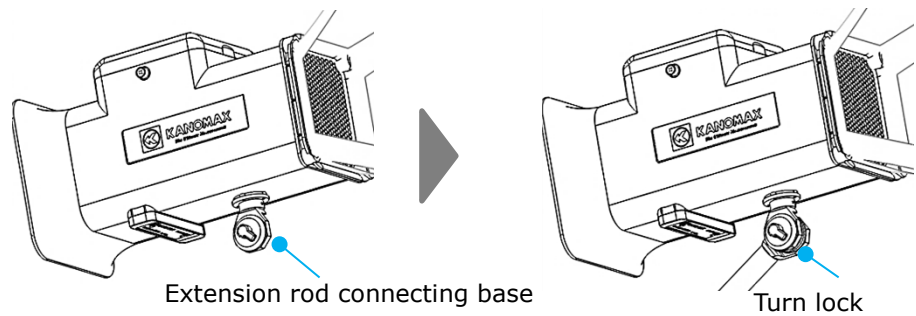

- ! When storing the instrument in the carrying case, remove the hood and extension rod so as not to damage the carrying case.

Assembling the Indicator and Jig

- Open the turn knob of the indicator fixing jig and attach the jig to the extension rod. Then tighten the knob to fix the jig in place.

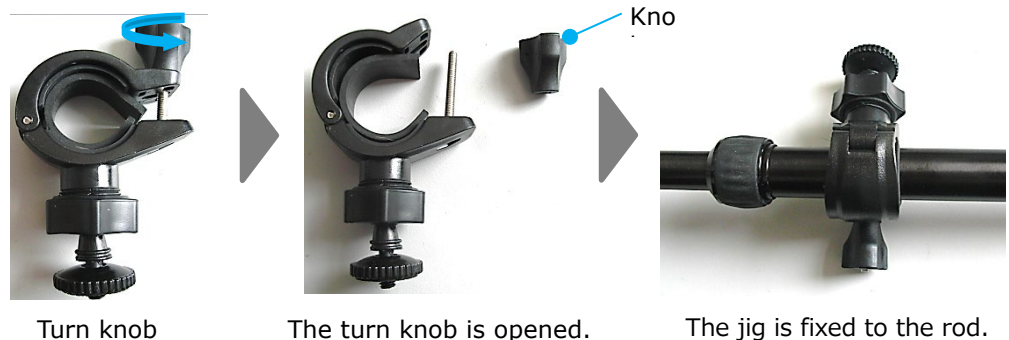

- Affix the indicator to the jig as shown below:

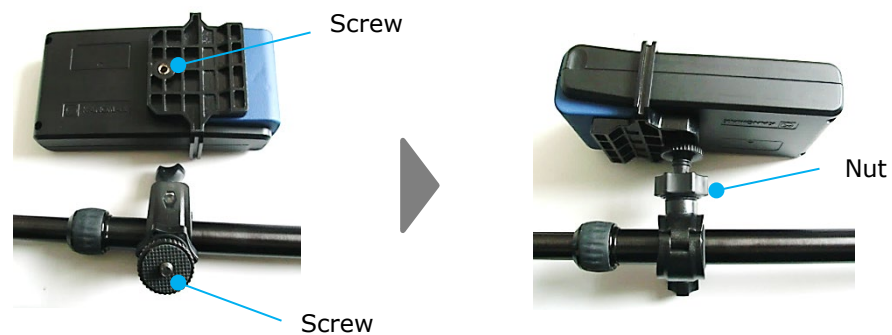

- Loosen the nut to adjust the angle of the indicator. Set the desired angle and tighten the nut to fix it in place.

Connecting the Main Body and Indicator

- Insert the Main Body-Indicator cable to the indicator connector of the main body and to the main body connector of the indicator.

Chapter 3 Operation Procedure

AC-powered Operation

With batteries installed, Connect the AC Adaptor (optional item) to the instrument to supply power from the AC adaptor.

Specification of the AC Adaptor

Input: AC 110 to 240V, 50/60 HZ Output: DC 5V/ 2A

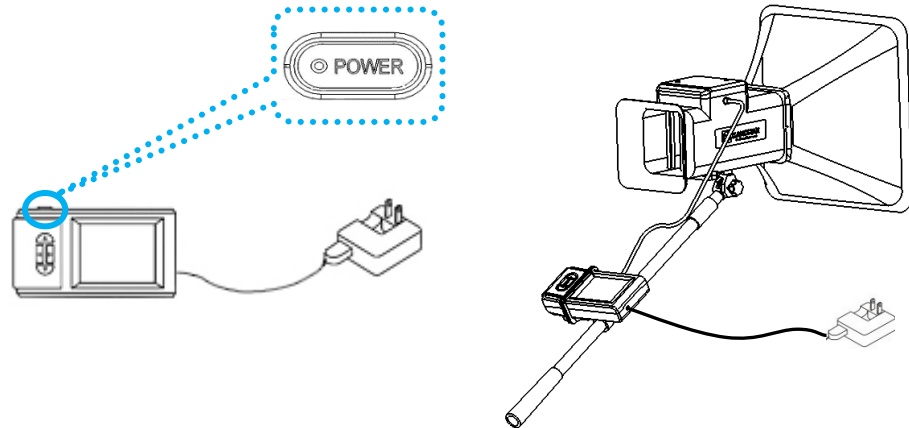

AC-powered operation is available.

Battery-powered Operation

Use four (4) AA batteries for battery-powered operation.

- Hold down the battery cover lock (Fig.①) on the indicator and slide open the battery cover.
- Insert four (4) AA batteries as shown in the battery compartment. New alkaline batteries or rechargeable nickel-hydrogen batteries can be used.

Do not use different types of batteries at the same time.

It will cause a battery leak and possible malfunction.

- When the battery cover is slid back to the original position (Fig.②), it will automatically lock.

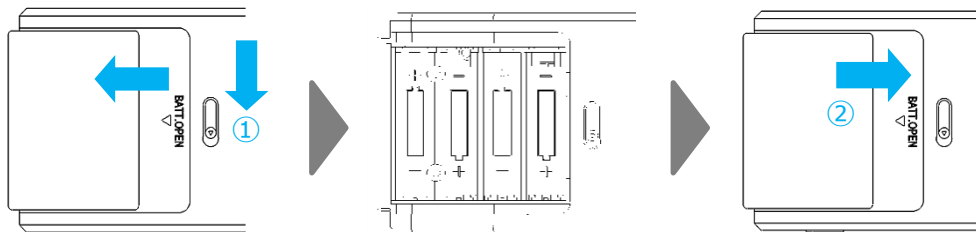

When the power is supplied using batteries, the remaining battery life is displayed in the upper right corner of the screen. As the remaining battery life falls, the battery life indicator will change as shown below. If the indicator says the remaining battery life is low, replace the batteries with new ones.



If the battery life lowers...

- A new measurement cannot be started.
- The current measurement might be interrupted.
- Setting operations for various functions might be interrupted

⊘ Do not use a new (fully charged) batteries and low-charged batteries at the same time.

Turning the Power ON/OFF

Turning the Power On

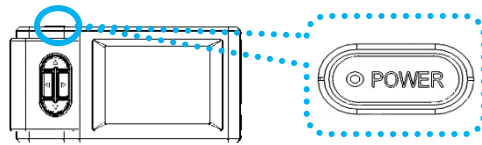

Hold down the [POWER] button at the top of the indicator. The atmospheric pressure setting screen will automatically be displayed.



Start Screen

↓ The screen is automatically displayed.



Atmospheric Pressure Setting Screen

Atmospheric Pressure
1 atmospheric pressure is equivalent to 1013 hPa (101.3 kPa).

↓ Press →



Main measurement screen

Turning the Power OFF

In any mode, holding down the [POWER] button for more than 2 seconds will turn the power off.

Operating the Instrument

Use the operation button on the indicator to operate the instrument. Grayed-out functions shown on the LCD screen are inactive ones. The ▶ mark on the LCD screen means pressing the operation button ▶ once; the ▶▶ mark means holding down the operation button ▶▶ for more than 2 seconds.

Definition of the Operation Button on the Indicator

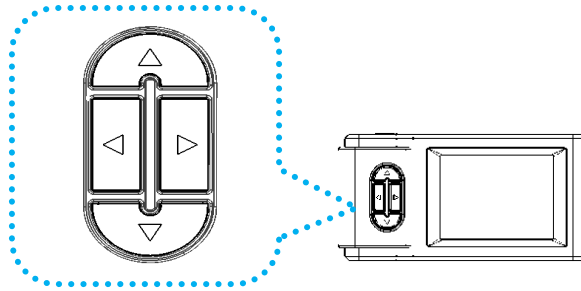

- ▶ : Starts a measurement on the measurement main screen;
Stops the measurement on the measurement main screen;
Cancels the current measurement;
Moves back to the previous screen.
- ▶▶ : Stores the setting;
Moves to the setting menu of the current item;
Moves to the main menu from the main measurement menu
(by holding down the button for 2 seconds).
- ▲ : Changes the value of the current setting item;
Stores the measurement value.
- ▼ : Changes the value of the current setting item.

Chapter 4 Measurement

Main Screen

After turning the power ON, the screen will automatically move to the atmospheric pressure manual setting screen and the current set value of atmospheric pressure will be displayed. Pressing ▲ or ▼ will set the atmospheric pressure value. Pressing ► will store the setting and move to the main screen for measurement.



- a. Airflow Graph Area
- b. Airflow and Temperature Display Area: displays the measured data of airflow and temperature.
- c. Power Supply Mode: displays the current power supply mode. (AC adaptor or battery mark)
- d. ID No.: displays the ID number to store airflow measurement data and the data number.
- e. Operation button: displays the contents of the button operations.

Measurement and Storing the Data

Press the "Start" button to start a measurement.



For a few seconds after pressing the start button, the airflow display

says - - - . After a certain period of time, the measured value will be displayed. (The measured value is updated once a second.)



Note: The displayed airflow value is an instantaneous value of every second.



To interrupt the ongoing measurement, press the [停止] button (◀). The final measurement value will be displayed.



To store the value of the interrupted measurement, press the [保存] button (▲).

When the data is saved, the Data Number is automatically increased by 1.

Chapter 5 Menu Operation

Displaying the Menu Screen



Hold down **▶** on the measurement main screen for more than 2 seconds to display the menu screen.



On the menu screen, the following Five (6) items can be set:

1. ID Set (ID Setting)
2. Display (Read data)
3. Delete (Delete data)
4. UPLink (Send data)
5. Print (Print data)
6. Set (Bluetooth)

ID Set (ID Setting)

Up to 60 IDs can be set. In a single ID, up to 100 measuring data can be saved.



On the menu screen, press **▲** or **▼** to select [ID setting] and tap **▶** to move on the [ID Setting] screen.

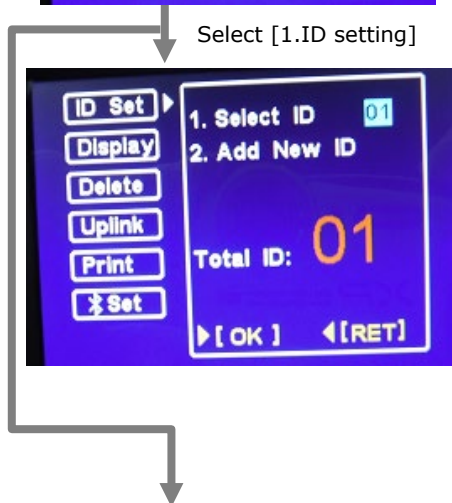

When [1. ID Setting] is selected, tap **▲** or **▼** to change the ID value.

Select [2. New ID]

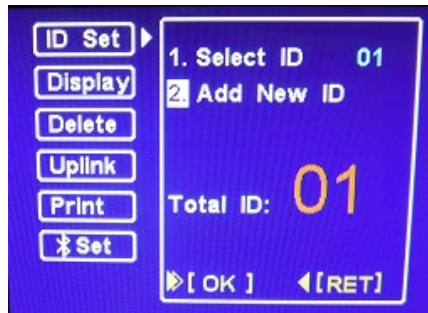

Select [2. 新規ID (New ID)] to set a new ID.

Hold down ▶

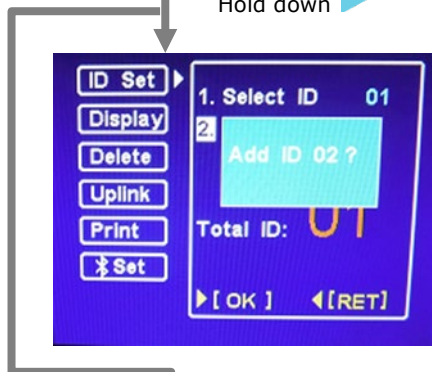

Press ▶ to add a new ID, and tap ◀ to cancel to add a new ID.

No data is stored in a new ID



If no measurement data is stored in a new ID, an additional new ID cannot be created.

Display (Read data)

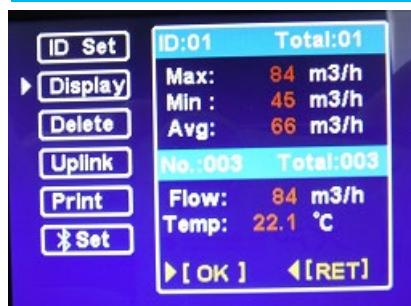

Press ▲ or ▼ on the menu screen and select [display (Read)].

Press ▶ to move on the data reading screen.

Tap ◀ to go back to the menu screen.

Tap ▶

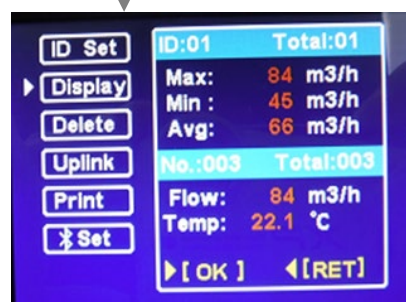

“±” of the airflow value means airflow direction.

Press ▶ to select an item.

Press ▲ or ▼ to change the values of ID and/or No.

Press ▶



Press ◀ to go back to the previous screen.

Delete (Delete data)

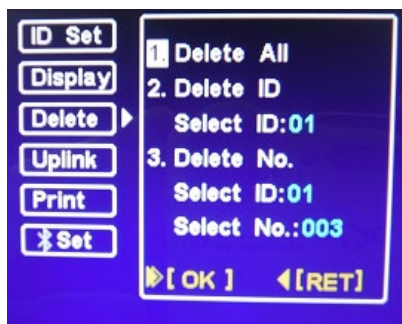

Select [Delete] on the menu screen. [Delete All], [Delete by ID] and [Delete by No.] are available.

Tap ▶ to go back to the [Delete] screen.

Tap ◀ to go back to the menu screen.

Delete (Delete All)

This function deletes all IDs and measurement data under the all IDs. Press ▲ or ▼ to select [1. 全削除 (Delete All)]. Hold down ▶ for 2 seconds to display the confirmation message.



Press ▶ to delete all. Press ◀ to cancel [Delete All].

Delete by Data No. Entry

This function deletes a selected data.



Press ▲ or ▼ to select [3.Data to Delete (Delete data)]. Make selection by pressing ►.



Press ▲ or ▼ to select the ID number to be deleted.



Press ▲ or ▼ to select the Data number to be deleted.

Hold down ► for 2 seconds to display the confirmation message.

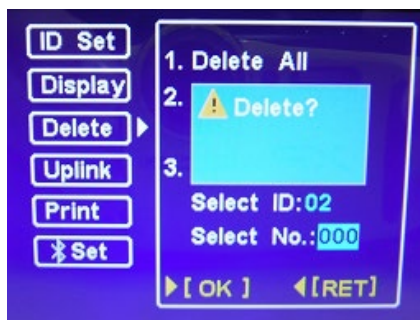

Press ► to delete the selected data.
Press ◀ to cancel to delete.

Uplink (Send data)

In prior to this setting, be sure to confirm the connection of the communication cable and the PC and to execute the provided Measuring Software (Model 6750-40) .

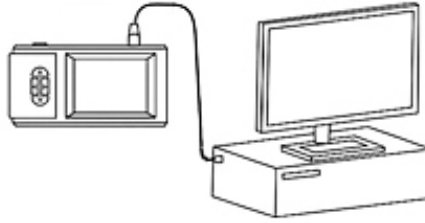

The indicator is connected to the PC.

With the menu screen displayed, press ▲ or ▼ to select [転送 (Send)]. Press ▶ to move to the 転送 (Send) screen.

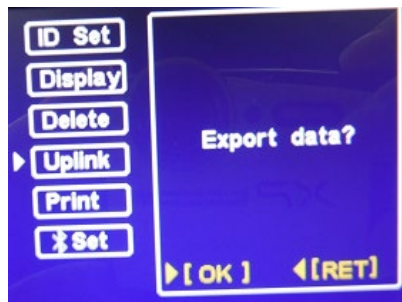

Press ▶ to start the connection.
Press ◀ to cancel the connection.

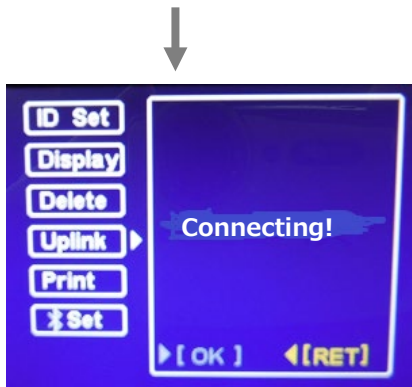

Press ▶ to start the connection between the main body and the PC. If an error occurs in a process of connection, the Error [Connect Error] as shown lower left will be displayed.

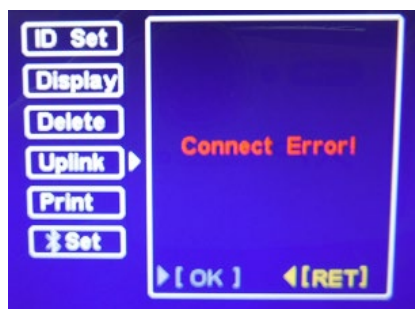

Print Setting



In prior to printing, confirm the following points:

- Be sure to use the designated printer and printer cable.
(For details, refer to the user's manual "DPU-S245 Printer".)
- Make sure that the baud rate of the printer is set to 19200.



With the menu screen displayed, press ▲ or ▼ to select [印字 (Printing)].

Press ▶ to move to the Print Setting (印字設定) screen.

Press ◀ to go back to the previous screen.

Print by ID Entry

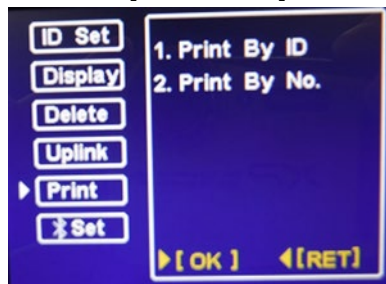

Press ▶ to select [1. Print by ID (Print by ID Entry)].

Press ◀ to go back to the setting screen.

Press ▶



Set the Start ID number by pressing ▲ or ▼.

Hold down ▶ for 2 seconds to display the [Print] message.

Press ◀ to cancel.

Press ▶



Screen while printing

Print by Data Entry

Select [2. Print by No. (Print by Data Entry)] and press ▶ to move to the setting screen. After that, follow the same process as the above [Print by ID (Print by ID Entry)].

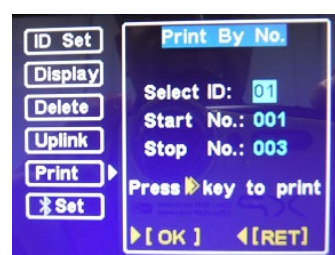

Bluetooth

With the menu screen displayed, press ▲ or ▼ to select [Set]
Press ▶ to move to the setting screen.

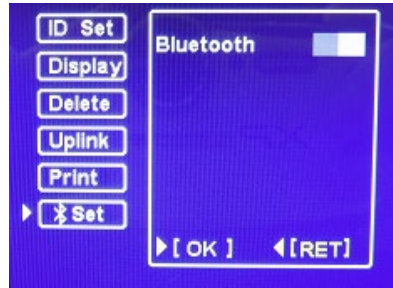

Hold down ▶ for 2 seconds to display the [Model name-serial number]

Hold down ▶ for 2 seconds to cancel.

To connect from OS device (iPhone, iPad) to 6750, can operate 6750 from OS device and it can send the data with e-mail.

Need to download [TABmaster-s] from App Store in advance the connection.

Chapter 6 Other Settings

Setting Screen

Hold down the ▲ and ◀ buttons at the same time and turn the power ON to move to the setting screen as below.

Press ▲ or ▼ to select the setting items and press ▶ to set measurement unit and K factor for each item.

After all the settings are complete, turn the power OFF. When turning the power ON again, the setting will be applied.

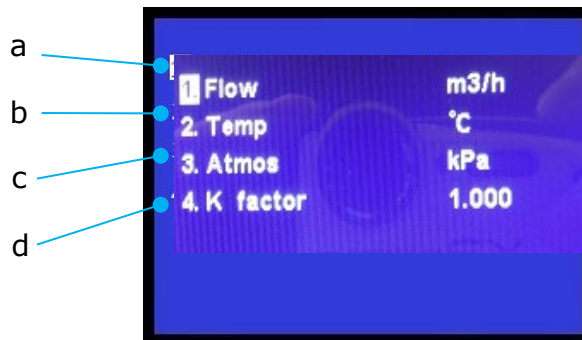

- a. Airflow unit setting (m^3/h / CFM) Default unit: m^3/h
- b. Temperature unit setting ($^{\circ}\text{C}$ / $^{\circ}\text{F}$) Default unit: $^{\circ}\text{C}$
- c. Atmospheric pressure unit setting (kPa / inHg) :
Default unit: kPa
- d. K factor setting (0.500 to 1.500) : Default value: 1.000

Setting and Storing the Airflow Unit

Select [1.風量 (Airflow)] and press ▶ button to display the list of [m^3/h] and [CFM]. The currently selected unit is highlighted in white as shown in the lower right figure.

Press ▲ or ▼ to select the unit and press ▶ to store the setting of the unit.

Pressing ◀ will cancel the setting and go back to the previous screen.

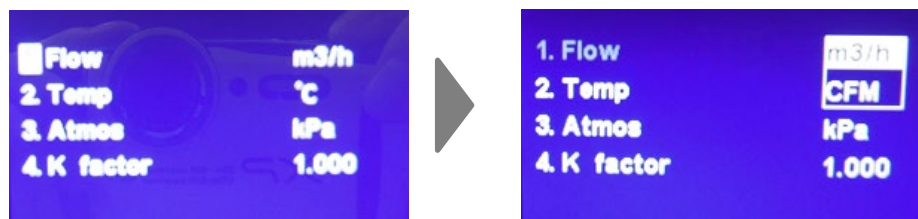

Setting and Storing the Temperature Unit

Select [2.Temp(Temperature)] and press ► button to display the list of [°C] and [°F].

The currently selected unit is highlighted in white as shown in the lower right figure.

Press ▲ or ▼ to select the unit and press ► to store the setting of the unit.

Pressing ◀ will cancel the setting and go back to the previous screen.

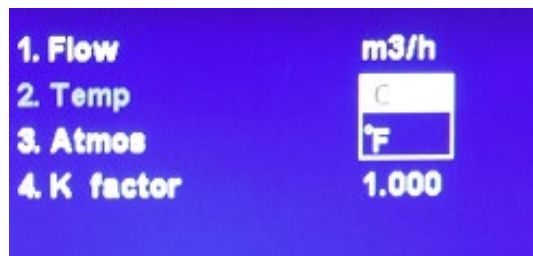

Setting and Storing the Atmospheric Pressure Unit

Select [3.Atmos (Atmospheric Pressure)] and press ► button to display the list of [kPa] and [inHg]. The currently selected unit is highlighted in white as shown in the lower right figure.

Press ▲ or ▼ to select the unit and press ► to store the setting of the unit.

Pressing ◀ will cancel the setting and go back to the previous screen.

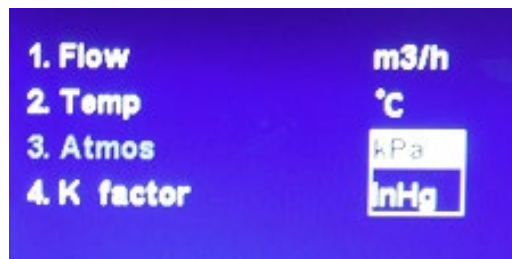

Setting and Storing the K-Factor

Select [4.K factor] and press ► button to display the [K factor] setting.

Press ► to store the setting value.

Press ◀ to cancel the change of the settings and to go back to the previous screen.

What is "K factor"?

A measured value shall be multiplied by the K factor, which is set here. The result of the multiplication will be displayed and stored as airflow value.

Use 1.000 for normal measurements.

The range of settable K factor is from 0.500 to 1.500, at 0.001 intervals.

Note: If ▲ is pressed when displaying 1.500, the setting will be changed to 0.500; if ▼ is pressed when displaying 0.500, the setting will be changed to 1.500.

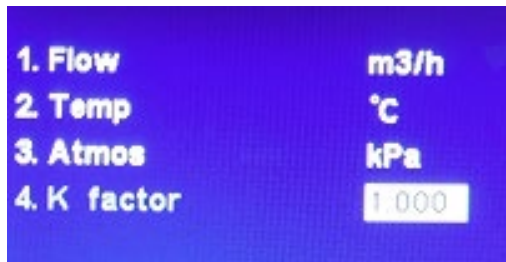

A screenshot of a blue LCD screen displaying a menu with four items. The first three items are '1. Flow', '2. Temp', and '3. Atmos', each followed by its unit: 'm3/h', '°C', and 'kPa' respectively. The fourth item is '4. K factor', followed by a white rectangular box containing the value '1.000'.

1. Flow	m3/h
2. Temp	°C
3. Atmos	kPa
4. K factor	1.000

Chapter 7 Main Specification

MODEL		6750
Measuring Range	Airflow	±8 to 600 m ³ /h
	Temperature	0 to 50°C
Measuring Accuracy	Airflow	8~350 m ³ /h : ± (Reading x 3% + 1digit m ³ /h) 350 to 600 m ³ /h : ± (Reading x 5% + 1digit m ³ /h)
	Temperature	±0.5°C
Resolution	Airflow	1 m ³ /h
	Temperature	0.1°C
Operating Environment		0 to 50°C (No condensation)
Storage Environment		-10 to 50°C (No condensation)
Atmospheric pressure compensation		By a manual setting of atmospheric pressure value
Data Storage		6,000 data
Communication		Bluetooth®, Digital Output: USB
Power Supply		AA Battery x 4, AC adaptor (Option)
Dimension of the hood		355×355 mm
Weight		1.5 kg
Accessories		Indicator, Indicator Fixing Jig, Extension Rod, Carrying Case, Hood (355×355 mm), USB Cable, Main Body-Indicator Cable (2m), AA Batteries (4 pieces), Measuring software (CD-R), User's Manual (this document), Insp document), Inspection Report
Options		Spare Hood (6750-01), Hood Edge Urethane Rubber (6750-02), Hood support pole (6750-07), Main Body-Indicator Cable (6750-08), USB Communication Cable (6750-09), Measuring Software (6750-40), Printer (NP-DPU-S245), Printer Roll Paper (TP-202L), Printer Cable(6750-10), Carrying Case (6750-B1), AC adaptor (Model 3887-01), Traceability

Chapter 8 Troubleshooting

Problem	Possible Cause(s)/ Solution(s)
No display on the screen	Batteries are inserted in wrong polarity. → Turn the power OFF and insert the battery correctly.
	The battery level is low. → Turn off the instrument and replace the batteries with new ones.
Measured data cannot be stored.	The current ID already contains 100 data. → Create a new ID.
A new ID cannot be created.	The ID has already been a new one. → Use the current ID to measure and store the data.
	ID numbers are fully assigned. → If the number of the IDs has reached 60, delete some IDs.
Printed data texts are unreadable.	The baud rate may not be set properly. → Reset the printer's baud rate correctly.
Pressing the [開始 (Start)] button does not start measuring.	Check the connection between the main body and communication cable. → Reconnect and turn the power ON again.
	The remaining battery level is low. → Replace the batteries with new batteries or use the optional AC adaptor (5V/2A).

Chapter 9 Warranty and After-sales Services

The limited warranty set forth below is given by KANOMAX JAPAN, Inc. (hereafter referred to as "KJI") with respect to the KANOMAX brand airflow meter, and its attachment parts including other accessories (hereafter referred to as "PRODUCT") purchased directly from KJI or from an authorized distributor.

Your PRODUCT, when delivered to you in new condition in its original container, is warranted against defects in materials or workmanship as follows: for a period of one (1) years from the date of original purchase, defective parts or a defective PRODUCT returned to KJI, as applicable, and proven to be defective upon inspection, will be exchanged for a new or comparable rebuilt parts, or a refurbished PRODUCT as determined by KJI. Warranty for such replacements shall not extend the original warranty period of the defective PRODUCT.

This limited warranty covers all defects encountered in normal use of the PRODUCT, and does not apply in the following cases:

- (1) Use of parts or supplies other than the PRODUCT sold by KJI, which cause damage to the PRODUCT or cause abnormally frequent service calls or service problems.
- (2) If any PRODUCT has its serial number or date altered or removed.
- (3) Loss of damage to the PRODUCT due to abuse, mishandling, alteration, improper packaging by the owner, accident, natural disaster, electrical current fluctuations, failure to follow operation, maintenance or environmental instructions prescribed in the PRODUCT's operation manual provided by KJI, or service performed by other than KJI.

NO IMPLIED WARRANTY, INCLUDING ANY IMPLIED WARRANTY OF MERCHANTABILITY OR FITNESS FOR A PARTICULAR PURPOSE, APPLIES TO THE PRODUCT AFTER THE APPLICABLE PERIOD OF THE EXPRESS LIMITED WARRANTY STATED ABOVE, AND NO OTHER EXPRESS WARRANTY OR GUARANTY, EXCEPT AS MENTIONED ABOVE, GIVEN BY ANY PERSON OR ENTITY WITH RESPECT TO THE PRODUCT SHALL BIND KJI. KJI SHALL NOT BE LIABLE FOR LOSS OF STORAGE CHARGES, LOSS OR CORRUPTION OF DATA OR ANY OTHER SPECIAL, INCIDENTAL OR CONSEQUENTIAL DAMAGES CAUSED BY THE USE OR MISUSE OF, OR INABILITY TO USE OR CONSEQUENTIAL DAMAGES CAUSED BY THE USE OR MISUSE OF, OR INABILITY TO USE, THE PRODUCT, REGARDLESS OF THE LEGAL THEORY ON WHICH THE CLAIMS IS BASED, AND EVEN IF KJI HAS BEEN ADVISED OF THE POSSIBILITY OF SUCH DAMAGES. IN NO EVENT SHALL RECOVERY OF ANY KIND AGAINST KJI BE GREATER IN AMOUNT THAN THE PURCHASE PRICE OF THE PRODUCT SOLD BY KJI AND CAUSING THE ALLEGED DAMAGE. WITHOUT LIMITING THE FOREGOING, THE OWNER ASSUMES ALL RISK AND LIABILITY FOR LOSS, DAMAGE OF, OR INJURY TO THE OWNER AND THE OWNER'S PROPERTY AND TO OTHERS AND THEIR PROPERTY ARISING OUT OF USE OR MISUSE OF, OR INABILITY TO USE, THE PRODUCT NOT CAUSED DIRECTLY BY THE NEGLIGENCE OF KJI. THIS LIMITED WARRANTY SHALL NOT EXTEND TO ANYONE OTHER THAN THE ORIGINAL PURCHASER OF THE PRODUCT, OR THE PERSON FOR WHOM IT WAS PURCHASED AS A GIFT, AND STATES THE PURCHASER'S EXCLUSIVE REMEDY.

After Service

•When you have a problem with your instrument, please check out "Troubleshooting" first.

•If that does not solve the problem, please contact your local distributor or call our service center. (See last page for contact information.)

•During the warranty period, we will repair at no charge a product that proves to be defective due to material or workmanship under normal use. (Kanomax Limited Warranty.)

•Repair after warranty expiration:

Upon request, we will repair the instrument at the customer's expense, if the instrument's performance is found to be recoverable by providing the repair.

•Replacement parts are available for minimum period of five (5) years after termination of production. This storage period of replacement parts is considered

as

the period during which we can provide repair service. For further information, please contact your local distributor or our service center.

Contact Information



U.S.A.

KANOMAX USA, INC.
PO Box 372, 219 Route 206, Andover, NJ 07821 U.S.A.
TEL: (800)-247-8887 / (973)-786-6386 FAX: (973)-786-7586
URL: <http://www.kanomax-usa.com/>
E-Mail: info@kanomax-usa.com

JAPAN

KANOMAX JAPAN, INC.
2-1 Shimizu, Suita City, Osaka 565-0805, Japan
TEL: 81-6-6877-0183 FAX: 81-6-6879-5570
URL: <http://www.kanomax.co.jp>
E-Mail: sales@kanomax.co.jp

CHINA

Shenyang Kano Scientific Instrument Co., Ltd.
#2610, 51 Wulihe Street Heping District Shenyang P.R.C.
TEL: 86-24-23846440 FAX: 86-24-23898417
URL: <http://www.kanomax.com.cn/>
E-Mail: sales@kanomax.com.cn



KANOMAX
The Ultimate Measurements